



# NOVA FLX S

NOVA 24V 5A FLX S, NOVA 24V 10A FLX S

350-155

Publication date 2025-11-06



## Table of Contents

1. Revisions and the edition of this document .....	4
1.1. Symbols .....	5
1.2. Variant overview NOVA .....	5
1.3. Installation — general information .....	6
1.3.1. Requirements for main switch, fuse and cable area .....	7
2. Component overviews .....	8
2.1. Component overviewNOVA FLX S .....	8
3. Enclosures .....	8
3.1. Console .....	8
3.2. Mounting .....	9
3.3. Mounting - wall mounting .....	9
4. Batteries - placement and connection .....	10
4.1. Connecting batteries in FLX S, 24 V .....	10
5. PRO3 motherboard .....	11
5.1. Motherboard - description .....	11
5.1.1. Fuses .....	12
5.1.2. Connect load .....	13
5.1.3. Dip switch 1-8 .....	13
Address setting for external communication (Dip switch 1-4) .....	13
Mains failure delay (dip 5-6) .....	14
Low battery voltage (dip 7) .....	14
LED (dip 8) .....	14
Battery test (dip 8) .....	14
5.1.4. Reboot to confirm changes in address, battery and alarm settings to parent system .....	15
5.1.5. Reset after battery replacement -PRO3 .....	15
6. Card Description - Relay Card NOVA Series (PRO3) .....	16
7. Multiple units into one parent system .....	17
8. Commissioning - how to start the unit .....	17
8.1. Connect in this order .....	17
8.2. System test .....	18
8.3. Recovery .....	19
9. Alarm displayed on cabinet door .....	19
10. Adjustment of tamper switch .....	20
11. Maintenance .....	20
11.1. About batteries .....	21
11.2. battery change .....	21
11.3. Battery recycling .....	21
12. Safety Information - Service and Troubleshooting .....	22
12.1. Troubleshooting .....	22
13. NOVA product sheet .....	23
13.1. SSF1014 certified battery backup with communication .....	23
13.1.1. Technical specifications .....	23
13.1.2. Name, article number and e-number .....	23
13.1.3. About NOVA FLX .....	23
Flexibility .....	24
Fixed installation .....	24
13.1.4. Area of use .....	24
13.1.5. Installation video .....	24
13.2. Regulations and certifications .....	25
13.2.1. Standards that product (s) meet and are approved for .....	25
13.2.2. Requirements that the product meets .....	25
13.3. Reserve operating times, power outlet and load output current .....	26



13.3.1. Charging current for batteries and battery capacity .....	26
13.3.2. Power outlet NOVA FLX .....	26
13.3.3. Permitted average load according to SSF1014 Alarm class 1-4: .....	27
13.3.4. Reserve operating times for different alarm classes - overview .....	27
13.4. Circuit boards - Technical data .....	27
13.4.1. Technical data, motherboard: PRO 3 .....	27
Alarm .....	27
13.4.2. Technical data, alarm card for PRO 3 / NEO3 .....	28
13.5. Power supply .....	29
13.5.1. Power supply - Technical Data LRS-150-24 .....	29
13.5.2. Power supply - Technical Data RSP-320-24 .....	30
13.6. Technical data enclosures .....	30
13.6.1. Enclosures - Technical Data FLX S .....	30
13.7. Link to the latest information .....	31
13.8. Warranty, support, country of manufacture and country of origin .....	31
13.8.1. Warranty 5 years .....	31
13.8.2. Manufacturer support .....	31
13.8.3. Support .....	31
Spare parts .....	32
Support after the warranty period .....	32
Questions about product performance? .....	32
13.8.4. Contact us .....	32
13.8.5. Country of manufacture .....	32
13.8.6. Designed and produced by: Milleteknik AB .....	32
13.9. Product life cycle, environmental impact and recycling .....	32
13.10. Batteries - recommended, not included .....	32
13.10.1. Batteries are not included they are sold separately .....	32
13.10.2. Battery combinations NOVA FLX S with Battery box 24V FLX S, (14 Ah batteries) .....	33
13.10.3. Certified with battery type .....	33
13.10.4. 14 Ah, 12 V AGM battery .....	33
13.10.5. Reserve operating times for different alarm classes - overview .....	33
14. Connection of battery box .....	34
14.1. Mounting for battery backup in FLX S housing .....	34
14.2. Connection battery box NOVA FLX with battery backup NOVA FLX .....	35
14.3. Wiring diagram and jumper .....	36
14.4. Tamper switch when using battery box(-es) .....	37
15. Address and contact details .....	37

## 1. REVISIONS AND THE EDITION OF THIS DOCUMENT

The current and most recently published edition of this document is available at [www.milleteknik.com](http://www.milleteknik.com).

The validity of this document can not be guaranteed, as new editions are published without prior notice.

Instructions for use in Swedish in original.<sup>1</sup>

Instructions for use, technical data and translations thereof may contain errors. It is always the responsibility of the installer to install the product in a safe manner.

---









<sup>1</sup>Translations in languages other than Swedish are indicative only and not safely reviewed. Translation should always be checked against the Swedish original to ensure accurate information





## 1.1. Symbols

Table 1. Symbol Explanation

Symbols	Denomination	Explanation
	Warning	Risk of electric shock, improper installation or hot surfaces. Appears in some manuals
	Note	Used for supplementary information that clarifies the text.
	Caution/Important	Indicates the risk of equipment damage or malfunction. Also used for information that is important but not security-related
	Tips	Displays practical advice or shortcuts for installation, operation, or service.
	CE marking	The product complies with applicable EU directives and harmonised standards.
	Read the manual	Please read manual before installation and service.
	Do not dispose of in household waste	The product is covered by the WEEE Directive and must not be disposed of with household waste, it must be recycled and delivered to a recycling centre.
	Recycling	Packaging, products and other materials that do not contain electronics must be recycled in accordance with local environmental regulations.

## 1.2. Variant overview NOVA

Table 2. Variant overview

Product name	Certified name	Mother-board: PRO1	Mother-board PRO2:	Mother-board PRO2 v3	Mother-board: PRO3
NOVA 12V 10A FLX S	12 V meets the requirements but is not certified.	-	-	-	x
NOVA 12V 10A FLX M		-	-	-	x
NOVA 12V 10A FLX L		-	-	-	x
NOVA 24V 5A FLX S	NOVA 25 50-FLX-S	X	X	-	X
NOVA 24V 10A FLX S	NOVA 25 100-FLX-S	X	X	-	X
NOVA 24V 5A FLX M	NOVA 25 50-FLX-M	X	X	-	X
NOVA 24V 10A FLX M	NOVA 25 100-FLX-M	X	X	-	X
NOVA 24V 15A FLX M	NOVA 25 150-FLX-M	X	X	X	-
NOVA 24V 25A FLX M	NOVA 25 250-FLX-M	X	X	X	-
NOVA 24V 5A FLX L	NOVA 25 50-FLX-L	X	X	-	X



Product name	Certified name	Mother-board: PRO1	Mother-board PRO2:	Mother-board PRO2 v3	Mother-board: PRO3
NOVA 24V 10A FLX L	NOVA 25 100-FLX-L	X	X	-	X
NOVA 24V 15A FLX L	NOVA 25 150-FLX-L	X	X	X	-
NOVA 24V 25A FLX L	NOVA 27 250-FLX-L	X	X	X	-



### READ THIS FIRST!

100 mm free space must be left on each card side. Ventilation must not be covered.

Electronics, regardless of enclosure, are intended for use in a controlled indoor environment. Mains voltage should be disconnected during installation.

It is the installer's responsibility that the system is suitable for its intended use. Only authorized persons should install and maintain the system.

All information subject to change.



### ABOUT GLASS TUBE FUSES ON CERTIFIED DEVICES

There are glass tube fuses on the circuit board's load outputs, these have a tripping time of approx. 150 ms. In the event that a glass tube fuse trips on ONE load output, the voltage on ALL load outputs drops to 0 V for 150 ms.

The installer is responsible for ensuring that there is an energy buffer of at least 150 ms in systems that the battery backup supplies power to or accepts a power failure of 150 ms.

## 1.3. Installation — general information

Installation shall be carried out by a competent electrician in accordance with the applicable national electrical installation rules.

The product is of protection class I and must be connected to a grounded 230 V AC circuit.

- A main switch according to IEC 60947-1 shall be provided in the fixed installation. The switch should be easily accessible and clearly marked with its function.
- The area of the supply cable shall be at least 1,0 mm<sup>2</sup> and fitted with a fuse T 2,5 A (slow-blown) or equivalent.
- AC and low voltage cables must not be pulled together. Keep separate cable chutes or bundles
- Check that protective earth (PE) is properly connected before turning on voltage.
- Ensure free air circulation around the enclosure at least 100 mm, unless otherwise specified. Ventilation openings must not be covered.
- The product is intended for indoor installation in normal environment (pollution number 2 and indoor class 1).

These general requirements apply to all Milleteknik products with 230 V mains connection.





### 1.3.1. Requirements for main switch, fuse and cable area

In order to comply with applicable electrical safety requirements, the installation shall be equipped with a main switch according to IEC 60947-1.

Table 3. Main switch and fuse

Component	Requirements
Main switch	A main switch according to IEC 60947-1 shall be included in the installation and be easily accessible. Separated phase (F) and neutral (N)
Fuse	The supply circuit shall be protected by a fuse or automatic fuse with rated current according to the product specification (normally T 2,5 A slow-blown or equivalent). Refer to the device's nameplate.
Fuses	Approved type according to IEC 60127.
Cross-sectional area (230 V)	At least 1,0 mm <sup>2</sup>
Cable length	In the case of longer wiring, voltage drops should be taken into account so that the operating voltage does not fall below 230 V ± 10% at the unit.
Strain relief	All cables must be properly secured and strain relief checked before energizing the unit.

These requirements apply to all Milletechnik products with 230 V mains connection.

The table below shows recommended cable area for low current installations at different voltages, current strengths and cable lengths. Values are based on copper cable and a maximum voltage drop of approximately 3% to ensure operational reliability.

Table 4. Cable area weak current

V	Current strength (A)	Cable length 10 meters	Cable length 30 meters	Cable length 60 meters	Cable length 100 meters
24V	1 A	0,75 mm <sup>2</sup>	0,75 mm <sup>2</sup>	1,5 mm <sup>2</sup>	1,5 mm <sup>2</sup>
24V	3A	0,75 mm <sup>2</sup>	0,75 mm <sup>2</sup>	1,5 mm <sup>2</sup>	2,5 mm <sup>2</sup>
24V	5A	0,75 mm <sup>2</sup>	1,5 mm <sup>2</sup>	2,5 mm <sup>2</sup>	4 mm <sup>2</sup>
24V	10A	1,5 mm <sup>2</sup>	2,5 mm <sup>2</sup>	6 mm <sup>2</sup>	-*
24V	15A	1,5 mm <sup>2</sup>	4 mm <sup>2</sup>	-*	-*
24V	25A	2,5 mm <sup>2</sup>	6 mm <sup>2</sup>	-*	-*
24V	40A	4,0 mm <sup>2</sup>	-*	-*	-*

\* Cable area would exceed connector terminal dimensions therefore it is not possible to use cable larger than 6 mm<sup>2</sup>



## 2. COMPONENT OVERVIEWS

### 2.1. Component overview NOVA FLX S

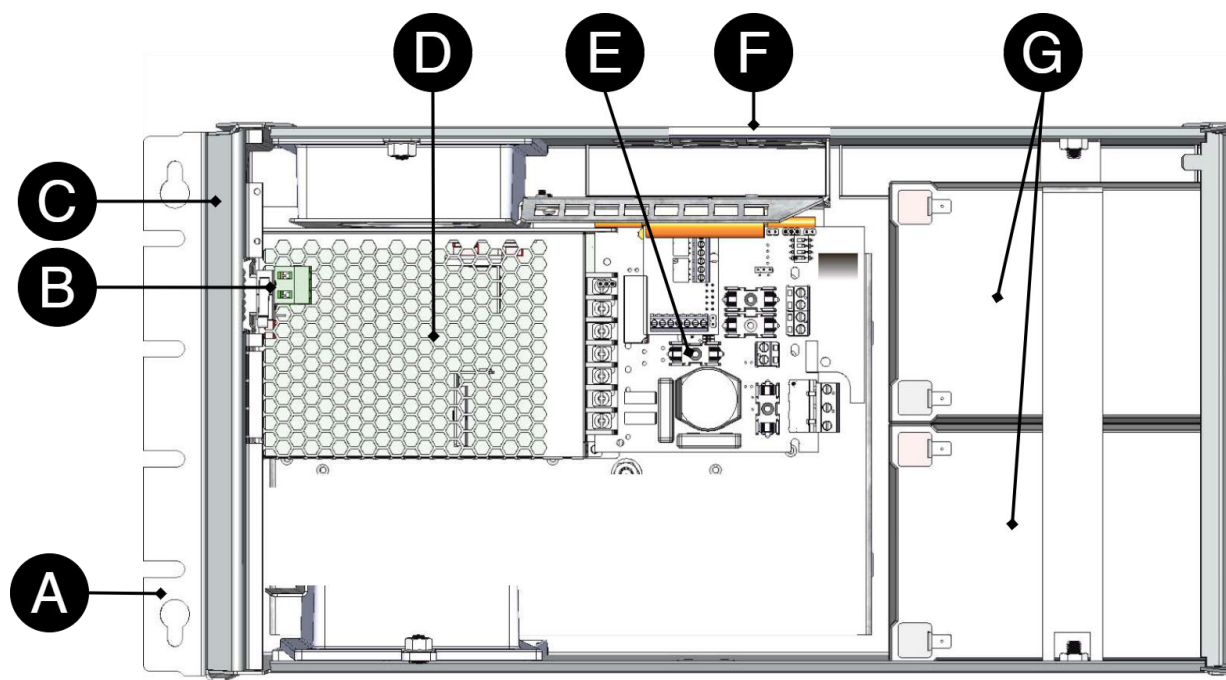

Table 5. Component overview

Number	Explanation
A	Bracket, reversible for wall mounting or 19" rack.
B	Sabotage contact. If alarm class 3 (SSF) is to be met, the tamper switch must be on the wall.
C	Cabinet in powder-coated sheet metal.
D	The power supply, location and type vary with configuration.
E	Motherboard.
F	Cable entries.
G	Space for batteries.

## 3. ENCLOSURES

### 3.1. Console

The supplied brackets can be attached in two ways: When mounting on a wall, the brackets must sit backwards, against the wall. When mounting in a 19" rack, the bracket must sit at the front of the unit.





Table 6. Console

Letter	Explanation
A	Console is pushed in from the bottom up.
B	Clip clicks in when bracket is pushed in correctly.



### IMPORTANT

If alarm class 3 (SSF) is to be met, the cabinet and tamper switch must be mounted on the wall. Optional, Cabinet tamper S to put a tamper switch on the wall is available.

## 3.2. Mounting

Use the appropriate screw for mounting on a wall or in a 19" rack. Screws for mounting on a wall or in a rack are not included.

## 3.3. Mounting - wall mounting

- The products shall be mounted on a stable wall or mounting plate with sufficient bearing capacity for the weight of the enclosure, including batteries.
- The enclosure is mounted vertically.
- Use four screws with a diameter of 4—5 mm, depending on the substrate.
- Recommended distance between screw head and wall should be 1.5-2 mm.
- For mounting on drywall, wall anchors or expanders should be used.
- When mounting on concrete or brick, dowels or equivalent fastening are used.
- For good ventilation, at least 100 mm of free space should be provided above and on the sides of the enclosure.
- The unit should be mounted at a comfortable working height, normally between 1.4 and 1.8 m above the floor.
- Avoid placement in direct sunlight, near heat sources, or in environments with high humidity or dust.
- For outdoor use, only enclosures with the specified IP class for outdoor use shall be used.
- Installation shall be carried out in accordance with the applicable installation rules and by a competent installer.



## 4. BATTERIES - PLACEMENT AND CONNECTION

### 4.1. Connecting batteries in FLX S, 24 V

Figure 1. Connection of batteries in FLX S. Motherboards may differ depending on the configuration, but connection of batteries is the same.

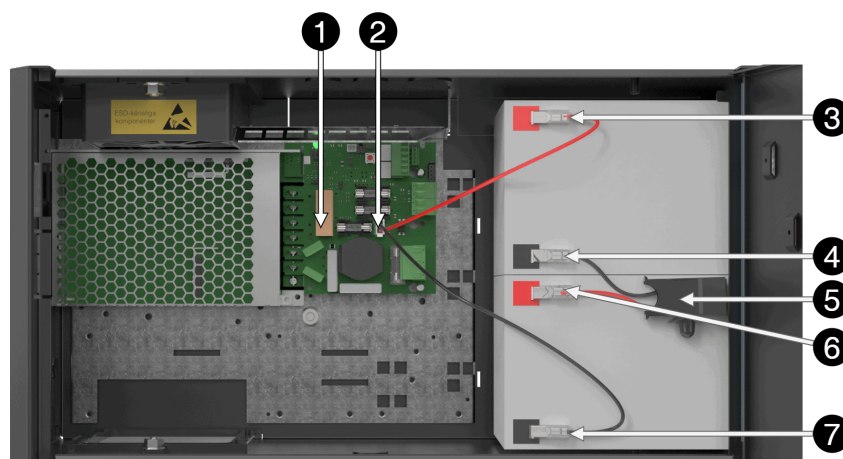

Note that cards (4) differ from different configurations.

Table 7. Connecting batteries.

No	Explanation
1	Motherboard, varies with configuration.
2	Battery cables are located on the motherboard.
3	Plus terminal for battery cable from 2.
4	Minus terminal is connected to 5, battery fuse.
5	Battery fuse.
6	Plus pole is connected to 5, battery fuse.
7	Minus terminal for battery cable from 2.





## 5. PRO3 MOTHERBOARD

### 5.1. Motherboard - description

Figure 2. PRO3

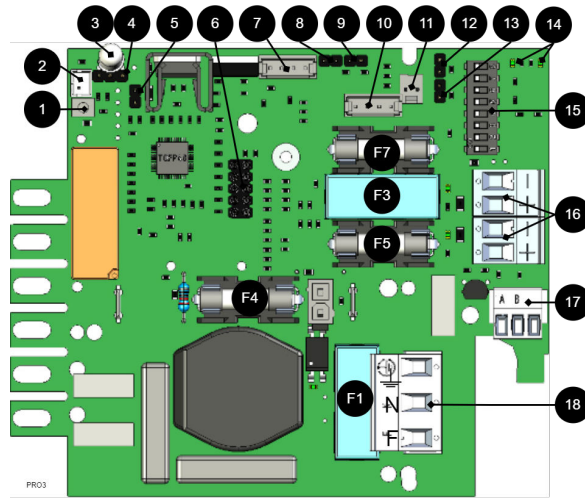

The motherboard controls the device and distributes power. See technical data for more information.

Table 8. Circuit Board Overview, Explanation

No .	On circuit board	Explanation
1	J24	Control to power supplies. Internal use.
2	J5	1=Oprio 2=external alarm.
3	D9	LED.
4	JU1	For external LED in door.
5	J11	Reset jumper, used when changing batteries.
6	JU6	Connection for relay cards or communication cards or for updating firmware. Only one card or contact at a time can fit.
7	J29	Connection to fan.
8	J101	Connection to tamper contact.
9	J17	Connection to tamper switch from battery box.
10	J35	Not used.
11	J14	Alarm input from external battery fuse, from battery box.
12 and 13	J10 and J100	Alarm from external option card.
14	D18, D19	LEDs show the status of communication (RS-485).
15	S3	Dip switch
16	P2:1-4	Load outputs
17	P3:1-3	Communication connection, RS-485.
18	P1:1-3	Connection to the mains.



## 5.1.1. Fuses

Table 9. Fuses on PRO3 / NEO3

Fuse	Type	Explanation
F1	T2.5A	Mains fuse
F3	T16A	Load fuse 1 - (for P2:2)
F4	T16A	Battery fuse
F5	T3A-T10A*	Load fuse 1+ (for P2: 1)
F7	T3A-T10A*	Load fuse 2 + (for P2:3)

\*The size of the fuse depends on the battery backup (rated) power outlet (A) .



### WARNING FOR REPLACING FUSES (CURRENT STRENGTH, A)

There is a risk of damage if the fuse is changed to a larger one than what the unit is delivered with. The function of the fuse is to protect the connected load and cables against damage and fire. It is not possible to change the fuse to a larger one to increase the power output.

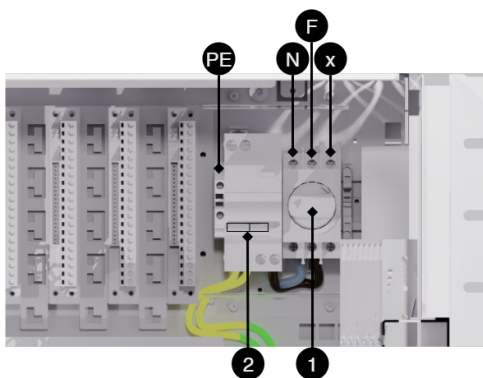

Table 10.

1	
2	
N	
F	
x	





### 5.1.2. Connect load



#### MAX CURRENT

The maximum current must not be exceeded. Max current is indicated on [nameplate](#) on the device.



#### LOAD OUTPUTS WHEN SSF CERTIFIED

In order for certificates to be maintained, only one load output must be used.

If there are one or more connection cards (to increase the number of load outputs), load must be connected there and not on the main board.

Table 11. Load connections

On circuit boards	Explanation
P2: 1	Connection for load 1 +.
P2: 2	Hookup for load 1 -.
P2: 3	Connection for load 2 +
P2: 4	Connection for load 2 -

### 5.1.3. Dip switch 1-8

Dip-Switch has several different modes:

Table 12. Dip switch 1-8

Dip switch	In mains operation or in battery operation
1	Address for external communication.
2	Address for external communication
3	Address for external communication
4	Address for external communication
5	Sets alarm for mains failure delay
6	Sets alarm for mains failure delay
7	Sets alarm limit for low battery voltage in battery operation.
8	Turns off or turns on LED indication, for everything except alarm in case of triggered tamper contact which is always indicated regardless of dip-switch position.
8 in sequence	Perform battery tests.

### ADDRESS SETTING FOR EXTERNAL COMMUNICATION (DIP SWITCH 1-4)

Dip-Switch S1: 1-4 sets addressing.

Table 13. Addressing Dip-Switch 1-4

	Dip: 1	Dip: 2	Dip: 3	Dip:4
Adress 1	ON	OFF	OFF	OFF
Adress 2	OFF	ON	OFF	OFF



	Dip: 1	Dip: 2	Dip: 3	Dip:4
Adress 3	ON	ON	OFF	OFF
Adress 4	OFF	OFF	ON	OFF
Adress 5	ON	OFF	ON	OFF
Adress 6	OFF	ON	ON	OFF
Adress 7	ON	ON	ON	OFF
Adress 8	OFF	OFF	OFF	ON
Adress 9	ON	OFF	OFF	ON
Adress 10	OFF	ON	OFF	ON
Adress 11	ON	ON	OFF	ON
Adress 12	OFF	OFF	ON	ON
Adress 13	ON	OFF	ON	ON
Adress 14	OFF	ON	ON	ON
Adress 15	ON	ON	ON	ON

## MAINS FAILURE DELAY (DIP 5-6)

It is possible to change the time for when the alarm for a power outage should be given. Use the matrix to set the alarm.

Table 14. Mains failure delay

Alarms for mains failure are given after:	Dip 5	Dip 6
3 seconds	OFF	OFF
30 minutes	ON	OFF
60 minutes	OFF	ON
240 minutes (4 hours)	ON	ON

## LOW BATTERY VOLTAGE (DIP 7)

Dip: 7 has the same function regardless of whether the unit is in mains or battery operation or whether the tamper switch is held down.

Table 15. Low battery voltage

Alarm for low battery voltage is given when	Dip 7
22,8 V*	ON
24 V	OFF
*25% of battery capacity remains.	

## LED (DIP 8)

LED/battery-test always lights up when the door is open.

Dip-switch 8=ON turns off the LED.

Dip-switch 8=OFF turns on the LED.

## BATTERY TEST (DIP 8)

To do a battery test, dip 8 needs to change position and five seconds need to pass before the test is initiated.

- If dip 8 in original position is on OFF then switch dip 8 to: ON (wait 5 seconds) and then switch back to OFF.
- If dip 8 in original position is on ON then switch dip 8 to: OFF (wait 5 seconds) and then switch back to ON.





This activates the battery test after 3-8 seconds. The battery test lasts for about 6 seconds and then the LED flashes yellow quickly. Aged battery alarms may be indicated while the battery test is being performed.

Only reset dip 8 when the test is complete.

#### 5.1.4. Reboot to confirm changes in address, battery and alarm settings to parent system

After the dip-switch has been set for various parameters, the device's software needs to be restarted. This is for the new settings to be stored and take effect.



#### **IMPORTANT**

Rebooting according to this procedure does not interrupt the output voltage.

Restarting the device software is done by jumpering J11 (PRO3)



#### **IMPORTANT**

Reboot must be done every time a change is made to the device.

NEO cannot be connected to communication/UC.

#### 5.1.5. Reset after battery replacement -PRO3

After battery replacement, the device needs to measure the capacity of new batteries and clear previously set battery capacity. All alarms are cleared from the units memory, statistics remains and can not be cleared.

- Insert jumper on J11 and remove jumper on J11

After doing step, the battery capacity is cleared in the units memory and is ready to read the new battery capacity.

This procedure needs to be done each time the batteries are replaced or when connecting a battery box.



#### **NOTE ON TEST OF BATTERIES**

At start-up, it takes 72 hours before the system performs battery tests. This is to ensure fully charged batteries and to collect averages / history for at least 72 hours. Thereafter, every four hours, a qualified cell sample of the batteries is performed.



## NOTE ON START-UP WITH SHORT-CIRCUITED BATTERIES

Peak current at start-up with short-circuited batteries: Up to 30 A p-p for 200 ms.  
Always follow the start-up procedure.

## 6. CARD DESCRIPTION - RELAY CARD NOVA SERIES (PRO3)

Relay card - description, connections and alarm outputs.

- All fault arm relays must be in the drawn state. Check that there is a gap between CO and NC. Put the measuring instrument on continuity measurement and test closure. This should then indicate a short circuit.
- All relay outputs are normally live and give an alarm in the event of no voltage.

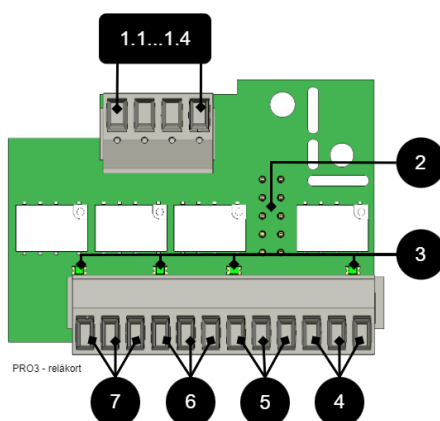

No .	Terminal no.	The relay is normally energized.	Alarm type / explanation
1.1...1.4	P4:1	-	GND, protective earth
	P4:2	-	RX
	P4:3	-	TX
	P4:4	-	+5V
2	JU5	-	Connection to motherboard.
3	D2-D6	-	Indicator diode, lit green when OK.
4	P5:10-12	NC, COM, NO	Alarm from tamper switch, (optional for NEO and EN54).
5	P5:7-9	NC, COM, NO	Low system voltage.
6	P5:4-6	NC, COM, NO	Alarm for fuse failure, charger failure overvoltage, charger failure undervoltage, battery not connected, low battery voltage in case of mains failure and aged battery*.  *NOVA only.
7	P5:1-3	NC, COM, NO	Mains failure alarm.



## 7. MULTIPLE UNITS INTO ONE PARENT SYSTEM

To connect several units to a higher system, the load-minus between several battery backups must be connected together.

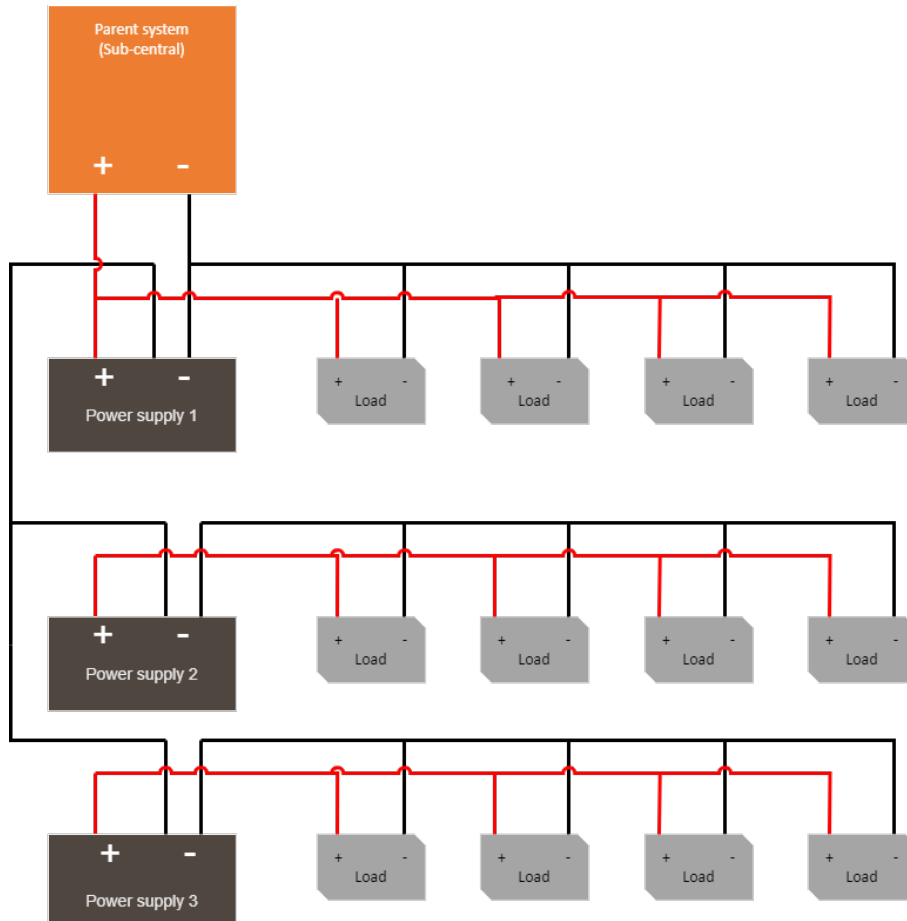

## 8. COMMISSIONING - HOW TO START THE UNIT

1. connect load, alarm and possibly. other connections.
2. Connect batteries
  - Connect / switch on fuses
3. Screw the mains cable into the terminal block and attach the terminal block to the motherboard.
  - Switch on mains voltage.

### 8.1. Connect in this order

To minimize the risk of errors that may occur in connection with a short circuit, connections to the motherboard must be made in this order.



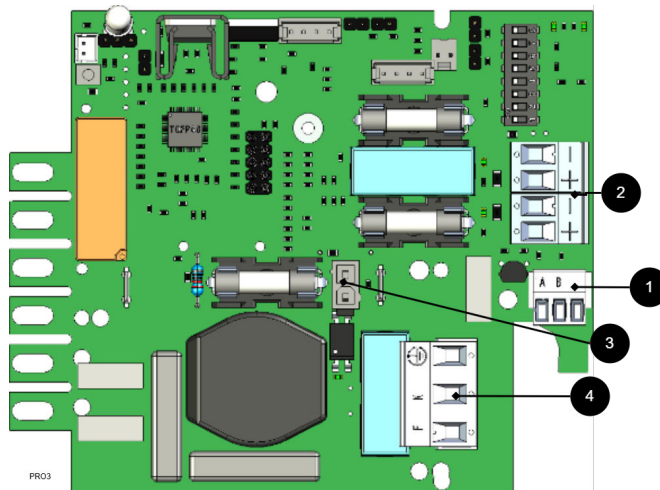

Table 16. Connect in this order

Nr	Explanation
1	Connect alarm.
2	Connect load.
3	Connect batteries
4	Connect mains.



### IMPORTANT

For setting dip switches and addressing — see online manual via QR code.

The unit works normally when the indicator LED on the outside of the cabinet door lights up with a solid green light. See front panel for other status indications.

It may take up to 72 hours before the batteries are fully charged.

## 8.2. System test

Test the connected device by performing a system test afterwards [commissioning \[17\]](#).



### IMPORTANT

Let the batteries charge for a couple of hours, use a multimeter to measure the voltage on each battery. The voltage must be at least 12.7 V per battery.

- Switch on incoming mains voltage.
- Indicator LED on the outside of the cabinet door lights up with a solid green light. Disconnect the mains voltage to check that the unit is operating in battery mode and alarms.
- LED on the cabinet door indicates, see panel for alarm type.





- Switch on incoming mains voltage. Indicator LED, on the outside of the cabinet door, lights up with a solid green light. Normal operation.

### 8.3. Recovery

Reset the unit by completely de-energizing the unit.

Disconnect battery wiring and mains voltage and reconnect after 5 seconds.

## 9. ALARM DISPLAYED ON CABINET DOOR

In normal mode, the indicator LED shows a solid green light.

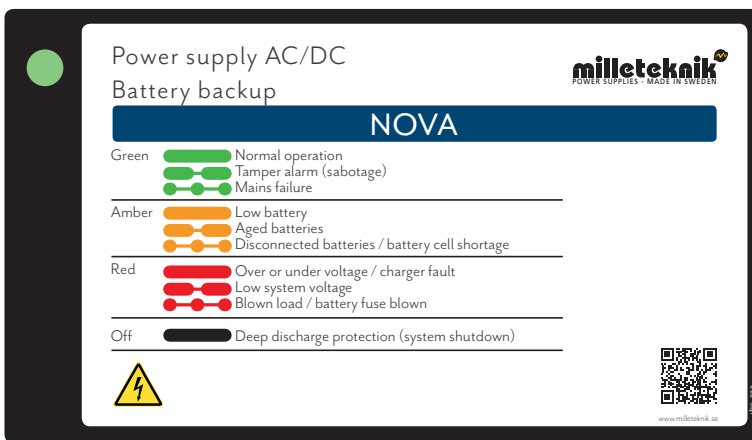

Table 17. The indicator diode shows.

The indicator diode (LED) shows	Explanation
Solid green light	Normal operation.
Slow green flashes	Sabotage alarm.
Fast green flashes	Mains failure.
Solid yellow light	Low battery voltage.
Slow yellow flashes	Aged batteries.
Rapid yellow flashes	Disconnected batteries or battery cell shortage.
Solid red light	Overvoltage or undervoltage or charger fault.
Slow red flashes	Low system voltage.
Rapid red flashes	Blown load or battery fuse has blown.
No light / off	Deep discharge protection is activated. (System shutdown).

When operating system: If the indicator LED is off, deep discharge protection has come into force.



#### NOTICE

If the indicator light flashes every 15 seconds, the battery is fully charged and the charge is in rest phase to extend battery life. In the event of a power failure during the rest phase, the battery backup switches to battery operation as usual



## 10. ADJUSTMENT OF TAMPER SWITCH

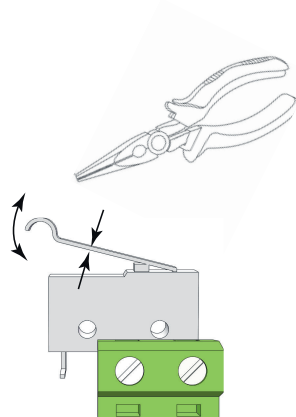

The tamper switch lever must be in the closed position when the cabinet door is closed. If the alarm goes off ("tamper alarm"), the lever may need to be adjusted.

The lever is adjusted by the following steps:

1. Pinch with pliers in the middle of the lever.
2. Carefully adjust the lever in the desired direction (up / down).
3. Check by closing the door. A click is heard when the contact is closed.



### NOTICE

Tamper switch will not give an alarm when closed and locked the door.

## 11. MAINTENANCE

The system with the exception of batteries is maintenance-free when installed in an indoor environment.

Check the fan annually. The fan should rotate smoothly without any noise. Clean the fan from dust and dirt. The fan must be replaced if it does not rotate smoothly or is so dirty that it cannot be completely cleaned. If the fan does not work well, the air flow in the unit will be obstructed, which leads to an increase in heat in the enclosure, which can lead to a deterioration of the battery capacity and to a significantly shorter battery replacement interval.





## 11.1. About batteries

Batteries generate electricity through a chemical process and there is thus a natural degradation of capacity. The biggest factor in battery life is temperature. The higher the temperature, the shorter the battery life. The date of manufacture stamped on the battery and the service life (as stated by the battery manufacturer). An ideal temperature is 20 °C both in operation and in storage. Higher ambient temperature greatly reduces the service life. Thus, actual lifespan varies when used. Batteries should be replaced after half specified (from the battery manufacturer) lifetime for safe operation. Batteries purchased through the manufacturer of the battery backup have a lifespan (from the battery manufacturer) of between 10-12 years with recommended replacement after 5-6 years.

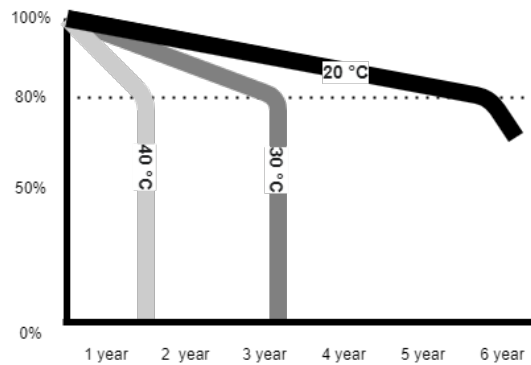

Table 18.



## 11.2. battery change

- If possible, disconnect mains (voltage) when replacing the battery.
- Disconnect battery cables. Note how battery cables are mounted before removing them.
- Remove battery fuse between batteries.
- Insert and fasten the new batteries.
- Connect the battery cables in the same way as before.
- Connect battery fuse between batteries.
- Switch on mains voltage. The indicator LED may not be green (up to 72 hours), until the batteries are charged.
- Test the system by briefly disconnecting the mains voltage, (= the load is driven by the batteries), and then switch on the mains voltage again.

## 11.3. Battery recycling

All batteries must be recycled. Return to manufacturer or return to recycling station.





## 12. SAFETY INFORMATION - SERVICE AND TROUBLESHOOTING

- If possible, disconnect the mains supply before starting any work, such as servicing, battery replacement, metering or troubleshooting.
- Remove the battery fuse/plug before working on the DC side.
- Check that all cables are properly connected and grounded before re-energizing the unit.
- The product may contain components that become hot during operation. Avoid touching internal parts immediately after the power has been switched off.
- If fuses disengage repeatedly see [Troubleshooting \[22\]](#) or disconnect the device and contact Milletechnik technical support.
- In case of suspicion of damage, liquid ingress or burnt odour, the product must not be used until it has been checked by competent personnel.
- During operation, the housing should be closed and locked (if the device has a lock).
- Only authorized service personnel may perform repairs on the device.
- Use only original fuses and batteries of the same type and value as specified in the manual/product sheet.

Milletechnik is not responsible for damage caused by improper handling, modification or unapproved components.

### 12.1. Troubleshooting

If the device does not work as expected, go through the following checks:

Table 19. Troubleshooting

Problem	Possible cause	Action
No output voltage.	No mains voltage, fuse triggered or battery failure.	Check the supply, fuses and battery connections.
Battery does not charge.	Faulty battery connection or battery fuse has blown.	Check battery cables and replace battery fuse if necessary.
The device starts but alarms.	Batteries not sufficiently charged or faulty load or battery.	Wait 72 hours until the batteries are fully charged. Ensure that the connected load does not exceed the rated current.
LED flashes.	Information, warning or error.	See panel or manual for explanation.
Fuses blow frequently.	Short circuit or overload.	Check connected devices, change the fuse only after the cause is fixed.
The device gets hot	High load or insufficient ventilation	Check that the rated current is not exceeded and that air flow is present around the housing.

If the problem persists after these checks, contact Milletechnik support and provide the product name, serial number and a brief error description.





## 13. NOVA PRODUCT SHEET

### 13.1. SSF1014 certified battery backup with communication

Figure 3. NOVA FLX S



NOVA FLX S can be mounted on a wall or in a 19" rack.

#### 13.1.1. Technical specifications

These technical specifications are subject to change without notice.

#### 13.1.2. Name, article number and e-number

Table 20. Name, article number and email number.

Name	Article number	E-number
NOVA 24V 10A FLX S	FS01P30024P100-SSF	52 135 63
NOVA 24V 5 A FLX S	FS01P30024P050-SSF	52 135 62

#### 13.1.3. About NOVA FLX

NOVA FLX is mainly used in safety systems where SSF 1014 approved battery backup is required or where the requirements are higher. Requirements such as better flexibility, more alarm functions, longer backup operating times or where the battery backup needs to handle higher loads.

The NOVA series is system certified according to SSF1014 together with most systems on the Swedish market. Milleteknik has the right to sell two different systems on the Swedish market; Sentrion NOVA The series has communication via RS485 to Sentrion S4, S4 DUO and CISS. Integra. Together with MOVEO kit (optional) there is RS232 communication with Integra MOVEO and MOVEO XL.

- SSF1014, Alarm class 1-3 approved battery backups / power supply.
- Controlled charging function.
- Qualified battery capacity test
- Can be supplemented with several different optional cards.



- Mounted on a wall or in a 19 "rack.
- Flexible battery capacity with battery boxes increases backup operating time.

## FLEXIBILITY

NOVA FLX S can have an extra battery box. NOVA FLX M and NOVA FLX L with 1-4 extra battery boxes \*. NOVA FLX M and NOVA FLX L with battery shelves in 19 "rack \*. \* The battery boxes and shelves are connected via a 9-pin connector. The battery box has room for up to 2 pcs. 45 Ah batteries per battery box. Battery shelves have room for 2 pcs. 45 Ah batteries (Medium) and up to 2 pcs. 150 Ah batteries (Large) per each battery shelf.

## FIXED INSTALLATION

The product is intended for fixed installation. The battery backup must be installed by a qualified installer.

### 13.1.4. Area of use

NOVA FLX mostly used for: Access control system, burglar alarms, (integrated security systems), in public environments such as schools, offices and commercial properties.



The unit meets the requirements for installation in systems that must be SSF 1014 approved. SSF 1014 certificate is only valid for certification together with a higher-level system.



### IMPORTANT

In order for the SSF 1014 certificate to be valid, only one (1) load output may be used.

### 13.1.5. Installation video

<https://www.milleteknik.se/nova-24-v-5-a-10-a-flx-s/>





## 13.2. Regulations and certifications

### 13.2.1. Standards that product (s) meet and are approved for

Table 21. SBF

SBF 110:8
-----------

Table 22. SSF

SSF1014 Alarm class 1-4 (burglar alarm).
SSF1014, Issue 5.

Table 23. Certificate and certificate number

Certificate number, SBSC	Designation SBSC
No. 18-246	NOVA 27 250-FLX, NOVA 27 150-FLX, NOVA 27 100-FLX, NOVA 27 50-FLX, NOVA 13 100-FLX, NOVA 27 100-XS2, NOVA 27 50-XS2, NOVA 27 30-XS2, NOVA 13 100-XS2, NOVA 13 50-XS2
No. 20-117	NOVA 27 50-FLX S • NOVA 27 100-FLX S • NOVA 27 50-FLX M • NOVA 27 100-FLX M • NOVA 27 150-FLX M • NOVA 27 250-FLX M • NOVA 27 50-FLX L • NOVA 27 100-FLX L • NOVA 27 150-FLX L • NOVA 27 250-FLX L Unison Facility Cabinet

Table 24. Certificate number RiSE

Certificate number, RiSE
SC0204-19

### 13.2.2. Requirements that the product meets

Table 25. The product meets the following requirements.

EMC:	EMC Directive 2014 / 30EU
CE:	EC Directive in force: 765/2008
Emissions:	EN61000-6-2:2001 EN 55022:1998: -A 1:2000, A 2:2003 Class B, EN61000-3-2:2001, EN 55032 (replaces EN 55022)
Machinery Directive	The product is part of electrical systems, is subject to the relevant electrical and safety directives and is not a machine according to the Machinery Directive (2006/42/EC).
Ecodesign	Milleteknik's products are intended for professional use and are therefore not directly covered by the Ecodesign Regulation (EU 2019/1782). As some components may be covered, we nevertheless disclose relevant information to give our customers confidence in their choice

Efficiency (%) <sup>a</sup>	Standby consumption, typical (W):
89%	3.38 W
89%	3.38 W

<sup>a</sup>At rated load.





## 13.3. Reserve operating times, power outlet and load output current

### 13.3.1. Charging current for batteries and battery capacity

The unit reads the connected system load and charges the batteries with available residual current from the power supply. The device performs qualified\* battery tests and notifies when batteries need to be replaced. The batteries are charged gently to extend their life and protection is available against overcharging.

Table 26.

12 V / 24 V	Maximum charging current for batteries
NOVA FLX S	4 A

The battery backup has controlled charging \*\* (controlled charging) which prevents batteries from being overcharged and extends their service life significantly. The NOVA series must be used with AGM batteries.

Table 27. Battery capacity in 24 V units

24 V	Battery capacity	Maximum battery capacity with 1 battery box	Maximum battery capacity with 2 battery boxes	Maximum battery capacity with 3 battery boxes	Maximum battery capacity with 4 battery boxes
NOVA FLX S, 24 V	14 Ah (2 x 14 Ah)	42 Ah (6 x 14 Ah)	70 Ah (8 x 14 Ah)	Not possible.	Not possible.

### 13.3.2. Power outlet NOVA FLX

NOVA 24V 5A FLX S	Unit without battery box	Unit with 1 battery box	Unit with 2 battery boxes
Battery	2 st 14 Ah	6 st 14 Ah	10 st 14 Ah
Max battery capacity	14 Ah	42 Ah	70 Ah
According to. SSF1014, Alarm Class 1-2	1.1 A	3.4 A	5.7 A
According to. SSF1014, Alarm Class 3-4	0.45 A	1.4 A	2.3 A
I <sub>max</sub> A (max discharge current)	5 A	5 A	5 A
I <sub>max</sub> b (max charging current)	5 A	5 A	5 A
I <sub>min</sub> is always 0 A.			

NOVA 24V 10A FLX S	Unit without battery box	Unit with 1 battery box	Unit with 2 battery boxes
Battery	2 st 14 Ah	6 st 14 Ah	10 st 14 Ah
Max battery capacity	14 Ah	42 Ah	70 Ah
According to. SSF1014, Alarm Class 1-2	1.1 A	3.4 A	5.7 A
According to. SSF1014, Alarm Class 3-4	0.45 A	1.4 A	2.3 A
I <sub>max</sub> A (max discharge current)	5 A	5 A	5 A
I <sub>max</sub> b (max charging current)	5 A	5 A	5 A
I <sub>min</sub> is always 0 A.			





### 13.3.3. Permitted average load according to SSF1014 Alarm class 1-4:

Table 28. NOVA 24 V FLX S

Permitted average load according to SSF1014 Alarm class 1-3:	NOVA 24V 5A FLX S	NOVA 24V 10A FLX A
FLX S, without battery box according to Alarm class 1-2 / Alarm class 3:	1.1 A / 0.45 A	1.1 A / 0.45 A
Including 1 pc. Battery box FLX S, according to Alarm class 1-2 / Alarm class 3:	3.4 A / 1.4 A	3.4 A / 1.4 A
Including 2 pcs. Battery box FLX S, according to Alarm class 1-2 / Alarm class 3:	-	5.7 A / 2.3 A

### 13.3.4. Reserve operating times for different alarm classes - overview

Alarm class	Spare operating time in the event of a power failure	Maximum number of hours of battery re-charging (80%)
EN54-4	-	24 h
SBF110: 8	30 h + 10 min	24 h
EN50131-6 grades 1-2	12 h	72 h
EN50131-6 grade 3	24 h	24 h
SSF1014 Alarm class 1/2	12 h	72 h
SSF1014 Alarm class 3/4	30 h	24 h

The table shows the requirements for backup operating time and recharging of batteries for different alarm classes.

## 13.4. Circuit boards - Technical data

### 13.4.1. Technical data, motherboard: PRO 3

Info	Explanation
Short name:	PRO 3
Product description	Motherboard in battery backup with advanced functions and communication to parent system.
Own consumption, with relay card	Less than 100 mA. All relays retracted on external alarm card in normal mode.
Switching time from mains voltage to battery operation	When batteries are idle: <5 microseconds. When batteries are in charge cycle: 0 (none). Batteries rest for 20-day cycles, after which a charging cycle picks up and charges the batteries for 72 hours. If there is a power failure when batteries are in the charge cycle, there is no switching time.
Incoming electricity network	230 V AC -240 V AC, 47-63 Hz.
Fuse on mains	See table: Fuses.
Indication	Indicator diode on circuit board / cabinet door

## ALARM

Alarm displayed on indicator LED on the front of the cabinet.

- Cell fault in battery or unconnected battery.
- Charger fault, undervoltage.
- Charger fault, overvoltage.
- Low system voltage, system voltage below 24.0 V in mains operation.



- Low battery voltage, below 24.0 V DC in case of mains failure.
- Power failure alarm.
- Sabotage switch.
- Fuse fault.
- Aged battery

Expanding alarm functions are available via communication or with alarm cards.

Table 29. Fuses

Fuses	Type
5 A	T5A
10 A	T10A
Mains fuse for 24 V units up to 15 A	T2.5AH250V. Ceramic.

Table 30. Protection

Info	Explanation
Deep discharge protection (Yes / No)	Yes. 12 V units protection at 10V, +/- 0.5 V. 24 V units protection at 20, +/- 0.5 V.
Surge protection (Yes / No)	Yes
Overtemperature protection (Yes / No)	Yes
Short circuit protected = (Yes / No)	Yes

### 13.4.2. Technical data, alarm card for PRO 3 / NEO3

Info	Explanation
Card name:	PRO 3
Version:	1.2
Product description	Motherboard in battery backup with advanced functions and communication to superior systems.
Recommended environment	Indoors, class 1. Ambient temperature: + 5 ° C - 40 ° C.
Protection class	IPX0
Recommended installation	NOVA Series (only 5 A and 10 A)
Input voltage	13.6 VDC, 27.3 VDC
Self-consumption	40 mA
Alarm via	Alternating relay
Number of alarm outputs	4 pcs
Certified according to	EN 50131-6, SBF 110: 8, SSF1014, Meets alarm class 4, SSF 1014, edition 5
Certificate number (SBSC)	20-117
The product meets the requirements according to	CE directive according to: 765/2008, EMC Directive 2014 / 30EU, Emission: EN61000-6-: 2001, EN55022: 1998: -A1: 2000, A2: 2003 Class B, EN61000-3-2: 2001, Immunity: EN61000- 6-2: 2005, EN61000-4-2, -3, 4, -5, -6, -11. SS-EN 50 130-4: 2011 Edition 2 & SSF1014 Alarm class 1-4 (Burglar alarm).
Producer	Milleteknik AB
Country of origin	Sweden

Manufactured in Milleteknik's factory in Partille, Sweden.

This translation is not verified and should be cross referenced with the swedish original before use.





Table 31. Alarm overview

Alarm overview in alphabetical order	Relay 1 * / Alarm output 1	Relay 2 * / Alarm output 2	Relay 3 * / Alarm output 3	Relay 4 * / Alarm output 4	Communication (P5: 1-9)	Indicator LED on main card and LED on door.
Network outages	X	-	-	-	X	X
Fuse fault	-	X	-	-	X	X
Sabotage switch	-	-	-	X	X	X
Fan fault	-	-	-	-	X	-
Charger fault, overvoltage	-	X	-	-	X	X
Charger fault, undervoltage	-	X	-	-	X	X
Cell fault or unconnected battery	-	X	-	-	X	X
Low system voltage. **	-	-	X	-	X	X
Low battery voltage (<24.0 V DC) or power failure	-	X	-	-	X	X
Overtemperature	-	-	-	-	X	-
Undertemperature	-	-	-	-	X	-
Undertemperature	-	-	-	-	X	-
Short battery life left	-	-	-	-	X	-
Aged battery	-	X **	-	-	X **	X **
Overcurrent 100%, minute average	-	-	-	-	X	-
Overcurrent 80%, daily average	-	-	-	-	X	-
Overcurrent 175%, second average	-	-	-	-	X	-
* Alarm on potential-free relay contact.						
*** Not on NEO battery backups.						

Table 32. RS-485 on relay board

RS-485 on P4: 1-4	Explanation
P4:1	GND
P4:2	RX
P4:3	TX
P4:4	+5V

## 13.5. Power supply

### 13.5.1. Power supply - Technical Data LRS-150-24

In:
NOVA 24V 5A FLX S

Info	Explanation
Output voltage	27.3 V
Output current:	0 A - 6.5 A



Info	Explanation
Output voltage, ripple	200 mVp-p
Overvoltage	28.8 V - 33.6 V
Voltage recharge, ripple / current limitation	Less than 0.6 Vp-p
Efficiency	89%
Current limitation	110% - 140%
Constant voltage	+/- 0.5%
Regulatory accuracy	+ / - 1.0%
Input current (230 V)	1,7 A
Mains voltage frequency	47 Hz- 63 Hz
Mains voltage	230 V AC - 240 V AC
Brand effect	156 W
Temperature range	-30°C - +70°C
Humidity range	20% - 90% RH non-condensed
<p>The power supply is adapted and calibrated with the battery / hardware of the battery backup. Only power and calibrated power supplies may be used. Contact support when changing power supplies. Use of power supplies coming from another source may cause damage not covered by the warranty. Warranty is canceled if power supplies (from a source other than support / designated by support) that are not correctly calibrated are used.</p>	

## 13.5.2. Power supply - Technical Data RSP-320-24

In:
NOVA 24V 10A FLX S

Info	Explanation
Output voltage	27.3 V
Output current	0 A - 13.4 A
Output voltage, ripple	150 mVp-p
Overvoltage	27.6 V - 32.4 V
Voltage recharge, ripple / current limitation	Less than 1.2 Vp-p
Efficiency	89%
Current limitation	105% - 135%
Constant voltage	+/- 0.5%
Regulatory accuracy	+/- 1.0%
Input current (230 V)	2 A
Mains voltage frequency	47 Hz- 63 Hz
Mains voltage	230 V AC - 240 V AC
Brand effect	321.6 W
Temperature range	-30°C - +70°C
Humidity range	20% - 90% RH non-condensed
<p>The power supply is adapted and calibrated with the battery / hardware of the battery backup. Only power and calibrated power supplies may be used. Contact support when changing power supplies. Use of power supplies coming from another source may cause damage not covered by the warranty. Warranty is canceled if power supplies (from a source other than support / designated by support) that are not correctly calibrated are used.</p>	

## 13.6. Technical data enclosures

### 13.6.1. Enclosures - Technical Data FLX S

Info	Explanation
Name	FLX S





Info	Explanation
Enclosure class	IP 32
Measure	Height: 222 mm, width 437 mm, depth 145 mm
Height units	5 HE
Mounting	Wall or 19 "rack
Ambient temperature	+ 5 ° C - + 40 ° C. For best battery life: + 15 ° C to + 25 ° C.
Environment	Environmental class 1, indoors. 20% ~ 90% relative humidity
Material	Powder coated sheet
Color	Black
Cable entries, number	4
Batteries that fit	2 pcs 7.2 Ah or 2 pcs 14 Ah.
Place for fan	Yes

## 13.7. Link to the latest information

Products and software are subject to updates, you will always find the latest information on our website.

[NOVA](#)

## 13.8. Warranty, support, country of manufacture and country of origin

### 13.8.1. Warranty 5 years

The product has a five-year warranty, from the date of purchase (unless otherwise agreed). Free support during the warranty period is reached at [support@milleteknik.se](mailto:support@milleteknik.se) or telephone, +46 31-34 00 230. Compensation for travel and or working hours in connection with the location of faults, installation of repaired or replaced goods is not included in the warranty. Contact Milleteknik for more information. Milleteknik provides support during the product's lifetime, however, no later than 10 years after the date of purchase. Switching to an equivalent product may occur if Milleteknik deems that repair is not possible. Support may be added (at Milleteknik's descretion) after the warranty period has expired.

### 13.8.2. Manufacturer support

Manufacturers provide support for the life of the product, however, for a maximum of 10 years after the date of purchase. Switching to an equivalent product may occur if the manufacturer deems that repair is not possible. Support costs will be added after the warranty period has expired.

### 13.8.3. Support

Do you need help with installation or connection?

You will find answers to many questions at: [www.milleteknik.se/support](http://www.milleteknik.se/support)

Phone: +46 31-340 02 30

Support is open: Monday-Thursday 08:00-16:00, Fridays 08:00-15:00. Closed 11:30-13:15.



## SPARE PARTS

Contacted support for questions about spare parts.

## SUPPORT AFTER THE WARRANTY PERIOD

Milleteknik provides support during the life of the product, but no longer than 10 years after the date of purchase. Replacement for an equivalent product may occur if the manufacturer deems that repair is not possible. Costs for support and replacement are added after the warranty period has expired.

## QUESTIONS ABOUT PRODUCT PERFORMANCE?

Contact sales: 46 31-340 02 30, e-mail: [sales@milleteknik.se](mailto:sales@milleteknik.se)

### 13.8.4. Contact us

Milleteknik AB

Ögärdesvägen 8 B

S-433 30 Partille

Sweden

+46 31-34 00 230

[www.milleteknik.se](http://www.milleteknik.se)

### 13.8.5. Country of manufacture

Country of manufacture / country of origin is Sweden. For more information, contact your seller.

### 13.8.6. Designed and produced by: Milleteknik AB

Designed and produced by Milleteknik AB

## 13.9. Product life cycle, environmental impact and recycling

The product is designed and constructed for a long service life, which reduces the environmental impact. The product's service life depends on, among other things, environmental factors, mainly ambient temperature, unforeseen load on components such as lightning strikes, external damage, handling errors, and more. Products are recycled by being handed over to the nearest recycling station or sent back to the manufacturer. Contact your distributor for more information. Costs that arise in connection with recycling are not reimbursed.



### 13.10. Batteries - recommended, not included

#### 13.10.1. Batteries are not included they are sold separately

Batteries are sold separately.





### 13.10.2. Battery combinations NOVA FLX S with Battery box 24V FLX S, (14 Ah batteries)

Battery capacity (Ah)	Battery type	Number of batteries	Batteries in unit
14 Ah	14 Ah	2 pcs.	2 in Battery Backup
42 Ah	14 Ah	6 pcs	2 in Battery Backup 4 in Battery Box
70 Ah	14 Ah	10 pieces.	2 in Battery Backup 4 in Battery Box 4 in battery box 2

### 13.10.3. Certified with battery type

The device is certified with a UPLUS battery that must be used to maintain the certificate.

### 13.10.4. 14 Ah, 12 V AGM battery

Fits in	Number of batteries
NOVA 24V 5A FLX S	2
NOVA 24V 10A FLX S	2

Battery type	V	Ah
Maintenance-free AGM, lead-acid battery.	12 V	14 Ah

Table 33. 10+ Design life \* battery

Article number	E-number	Article name	Terminal	Measure. Height width depth	Weight per piece	Make
MT113-12V14-01	5230537	UPLUS 12V 14Ah 10+ Design Life battery	Flat pin 6.3 mm	151x98x101 mm	4.2 kg	UPLUS

\*Design life is the shelf life in years for an unused battery. Environmental factors such as heat and load affect the service life. Batteries that have a durability (+10 Design Life) of 10+ years usually need to be replaced after 5-6 years.

### 13.10.5. Reserve operating times for different alarm classes - overview

The table shows the requirements for backup operating time and recharging of batteries for different alarm classes.



#### IMPORTANT

This is a guide and all times are approximate and may differ from actual times. Load, temperature and other factors come into play, which is why exact time can not be provided.

Applies to new batteries.

Amperage and batteries vary with configuration, check if the configuration can handle batteries and amperage.



Table 34. Backup operating times 24 V units - without battery box

Medium current	7.2 Ah	14 Ah	28 Ah	45 Ah
Loading	Backup operating time (approx.), Minutes			
0.5 A	450	820	1650	2350
1 A	260	485	970	1460
2 A	150	280	560	920
4 A	90	165	335	550
6 A	67	125	245	405
8 A	57	105	210	350
10 A	44	80	160	270
12 A	38	70	140	235
14 A	33	60	120	200
16 A	28	50	100	170
18 A	25	45	89	150
20 A	23	42	84	142

Table 35. Backup operating times 24 V units - with battery box, 28 Ah - 70 Ah

Medium current	28 Ah	42 Ah	65 Ah	70 Ah
-	4 batteries (14 Ah)	6 batteries (14 Ah)	4 batteries (20Ah + 45 Ah)	10 batteries (7 Ah)
Loading	Backup operating time (approx.), Minutes			
0.5 A	1650	2090	5574	3440
1 A	970	865	3252	2118
2 A	560	815	1770	1329
4 A	335	490	930	864
6 A	245	360	600	605
8 A	210	310	426	544
10 A	160	240	342	414
12 A	140	210	270	363
14 A	120	180	234	311
16 A	100	150	204	286
18 A	90	130	150	254
20 A	84	126	138	241

Subject to typos.

## 14. CONNECTION OF BATTERY BOX

### 14.1. Mounting for battery backup in FLX S housing

The battery box is mounted on a wall or in a 19" rack, below the battery backup.

Cable entries are located at the top of the housing and in the middle on its back.



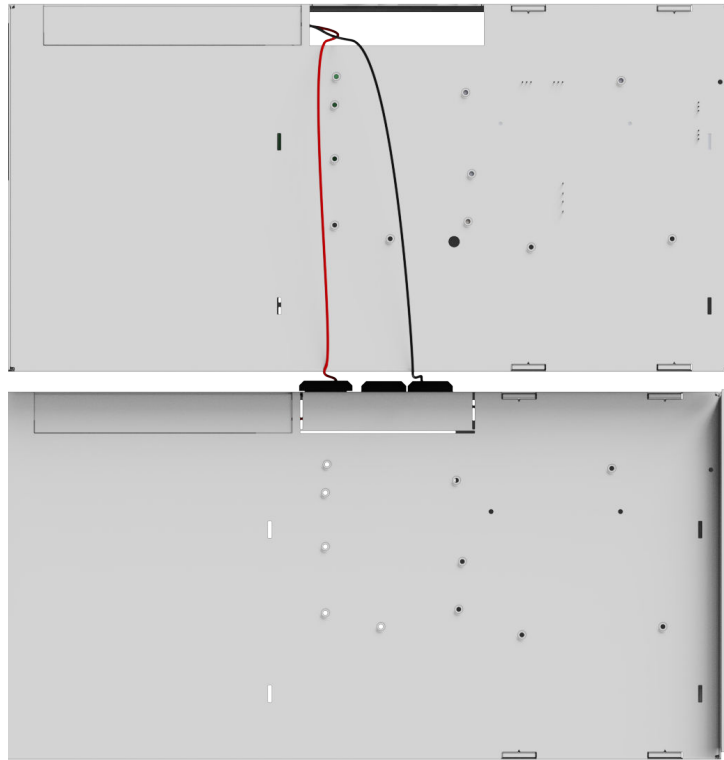

## 14.2. Connection battery box NOVA FLX with battery backup NOVA FLX

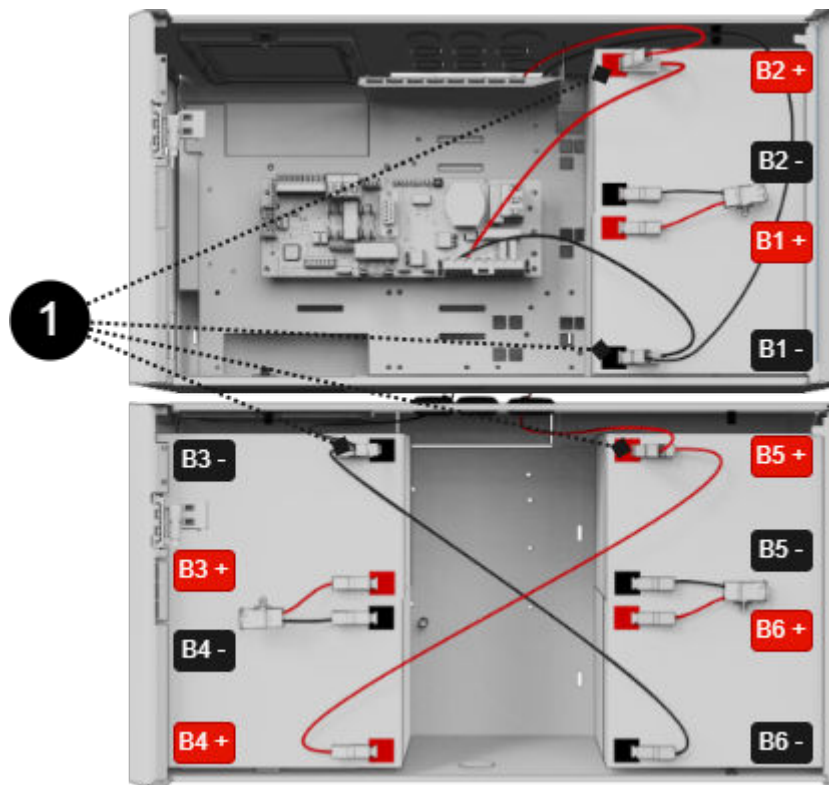

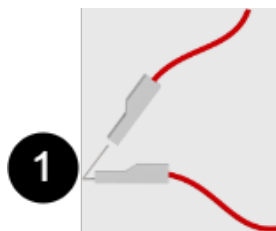

The picture shows a battery backup with extra battery box with 2 batteries.

The picture also gives an overview of connection points for battery cables and battery fuses.

Table 36. Connecting battery box.

Battery cables	Explanation
B1+	Connects to fuse
B1-	Cable from motherboard is connected to battery
B2+	Cable from motherboard is connected to battery
B2-	Connects to fuse
B3+	Connects to fuse
B3-	Connected via connector to battery in battery backup
B4+	Connected via connector to battery in battery backup
B4-	Connects to fuse
B5+	See B4+
B5-	Connects to fuse
B6+	Connects to fuse
B6-	See B3-

Table 37. Connection

Number	Explanation
1	Wiring from battery backup on double pin in battery backup.

### 14.3. Wiring diagram and jumper

Alarms for tamper contact are connected in series and therefore the loop must be unbroken to the last battery box wiring. Jumper closes the loop on each wiring that goes from battery backup to battery box and in order for an alarm to be given on the tamper connector in the battery box, a yellow jumper on wiring must be cut. Do not cut the jumper on the last wiring in the battery box, as sabotage alarms will not be given in any connected battery backup or battery box.

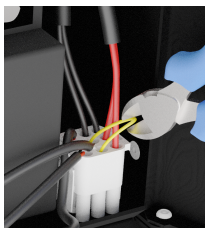

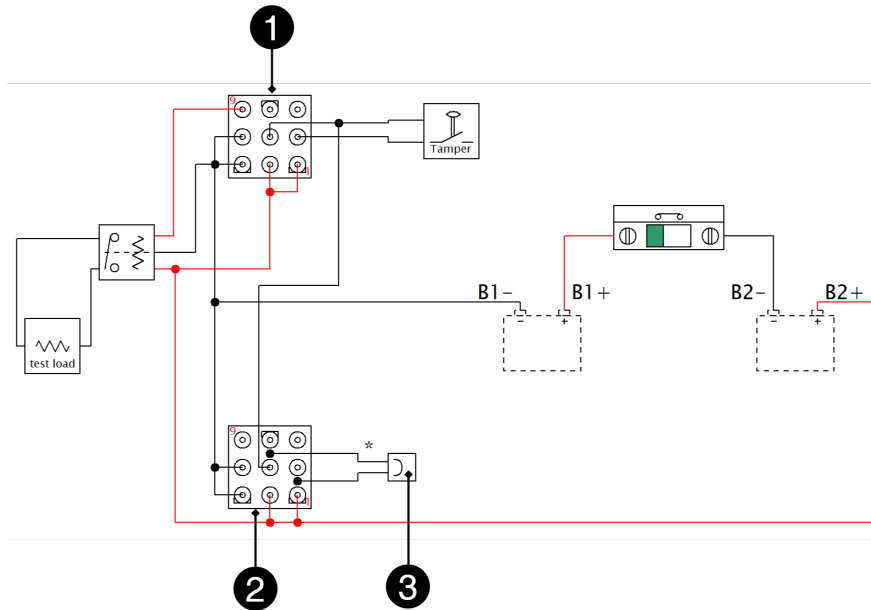

Table 38. Wiring diagram and jumper

Number	Explanation
1	IN - incoming connection
2	OUT - outgoing connection
3	Jumper on base on outgoing connection

Table 39. Wiring diagram and jumper

Devices	Yellow jumper - where to cut / not cut	Where the end of the loop should be
Battery backup without battery box	Do not cut the jumper	Jumper should remain in battery backup
Battery backup + 1 battery box	Cut jumper from battery backup	Jumper must remain in battery box 1
Battery backup + 2 battery boxes	Cut jumper in battery backup and from battery box 1	Jumper must remain in battery box 2

## 14.4. Tamper switch when using battery box(-es)

If one or more battery boxes have been connected to the unit, the tamper switch must be connected in series in order for alarms from all units to be given. It is important that the series connection ends at the last tamper contact. The series connection must start in the battery backup unit and return to the last battery box.

All tamper contacts must be in series for everyone to be part of the alarm chain. Therefore, the yellow cable that is in the jackable connector must be cut on all connecting cables, except the last one. The cable must not be cut on the last connection / battery box.

## 15. ADDRESS AND CONTACT DETAILS

Milleteknik AB  
 Ögärdesvägen 8 B  
 S-433 30 Partille  
 Sweden



+46 31 340 02 30  
info@milleteknik.se  
www.milleteknik.com



This page is intentionally left blank.

This page is intentionally left blank.