



# Power Supply

EN

BT-5 FLX Medium COM Gen2



350-255

Publication date 2025-11-06

Table of Contents

Safety Information - Service and Troubleshooting .....	5
Troubleshooting .....	5
Revisions and the edition of this document .....	5
Symbols .....	6
Installation video .....	6
Installation — general information .....	7
Requirements for main switch, fuse and cable area .....	7
You can find manuals at: <a href="http://www.milletechnik.se/rco-dokument">www.milletechnik.se/rco-dokument</a> .....	8
Links to manuals and product sheets .....	8
Address and contact details .....	8
Component overviews .....	9
Component overview BT FLX Medium COM Gen2 .....	9
Enclosures .....	9
Console .....	9
Mounting .....	10
Mounting - wall mounting .....	10
Optional cards for power supply .....	10
Batteries - placement and connection .....	11
Connect battery fuse / blade fuse .....	11
Connection of batteries in FLX S, FLX M and FLX L .....	11
PRO3 motherboard .....	12
Motherboard - description .....	12
Fuses .....	13
Connect load .....	14
Dip switch 1-8 .....	14
Reboot to confirm changes in address, battery and alarm settings to parent system .....	16
Reset after battery replacement -PRO3 .....	16
Card Description - Relay Card NOVA Series (PRO3) .....	17
Multiple units into one parent system .....	17
Bridge of UC-50 Gen2 .....	18
Bus communication - connection to UC-50 Gen2 .....	19
Commissioning - how to start the unit .....	21
Connect in this order .....	21
System test .....	22
Recovery .....	22
Alarm displayed on cabinet door .....	22
Adjustment of tamper switch .....	23
Maintenance .....	24
About batteries .....	24
battery change .....	24
Battery recycling .....	25
Appendix: Mount I2C board .....	25
Safety Information - Service and Troubleshooting .....	25
Troubleshooting .....	26
Power supply - product sheet .....	26
SSF1014 certified battery backup with communication .....	26

Name, article number and e-number .....	26
About BT FLX COM Gen2 .....	27
Area of use .....	27
Regulations and certifications .....	28
Standards that product (s) meet and are approved for .....	28
Requirements that the product meets .....	28
Power outlet per product .....	28
Circuit boards - Technical data .....	29
Technical data, motherboard: PRO 3 .....	29
Technical data, PRO3 I2C board .....	29
Power supply .....	30
Power supply - Technical Data LRS-150-24 .....	30
Technical data enclosures .....	31
Enclosures - Technical Data FLX M .....	31
Warranty, support, country of manufacture and country of origin .....	31
Warranty 5 years .....	31
Support .....	32
Country of manufacture .....	32
Designed and produced by: Milleteknik AB .....	32
Batteries - recommended, not included .....	32
Batteries are not included they are sold separately .....	32
20 Ah, 12 V AGM battery .....	32
Connection of battery box .....	33
Mounting battery box with battery backup .....	33
Installation of battery box, what to do in battery backup .....	33
Connection to batterybox .....	34
Address and contact details .....	35

## SAFETY INFORMATION - SERVICE AND TROUBLESHOOTING

- If possible, disconnect the mains supply before starting any work, such as servicing, battery replacement, metering or troubleshooting.
- Remove the battery fuse/plug before working on the DC side.
- Check that all cables are properly connected and grounded before re-energizing the unit.
- The product may contain components that become hot during operation. Avoid touching internal parts immediately after the power has been switched off.
- If fuses disengage repeatedly see [Troubleshooting \[5\]](#) or disconnect the device and contact Milleteknik technical support.
- In case of suspicion of damage, liquid ingress or burnt odour, the product must not be used until it has been checked by competent personnel.
- During operation, the housing should be closed and locked (if the device has a lock).
- Only authorized service personnel may perform repairs on the device.
- Use only original fuses and batteries of the same type and value as specified in the manual/product sheet.

Milleteknik is not responsible for damage caused by improper handling, modification or unapproved components.

## TROUBLESHOOTING

If the device does not work as expected, go through the following checks:

**Table 1. Troubleshooting**

Problem	Possible cause	Action
No output voltage.	No mains voltage, fuse triggered or battery failure.	Check the supply, fuses and battery connections.
Battery does not charge.	Faulty battery connection or battery fuse has blown.	Check battery cables and replace battery fuse if necessary.
The device starts but alarms.	Batteries not sufficiently charged or faulty load or battery.	Wait 72 hours until the batteries are fully charged. Ensure that the connected load does not exceed the rated current.
LED flashes.	Information, warning or error.	See panel or manual for explanation.
Fuses blow frequently.	Short circuit or overload.	Check connected devices, change the fuse only after the cause is fixed.
The device gets hot	High load or insufficient ventilation	Check that the rated current is not exceeded and that air flow is present around the housing.

If the problem persists after these checks, contact Milleteknik support and provide the product name, serial number and a brief error description.

## REVISIONS AND THE EDITION OF THIS DOCUMENT

The current and most recently published edition of this document is available at [www.rco.se](http://www.rco.se).









The validity of this document can not be guaranteed, as new editions are published without prior notice.

Instructions for use in Swedish in original.<sup>1</sup>

Instructions for use, technical data and translations thereof may contain errors. It is always the responsibility of the installer to install the product in a safe manner.

## SYMBOLS

Table 2. Symbol Explanation

Symbols	Denomination	Explanation
	Warning	Risk of electric shock, improper installation or hot surfaces. Appears in some manuals
	Note	Used for supplementary information that clarifies the text.
	Caution/Important	Indicates the risk of equipment damage or malfunction. Also used for information that is important but not security-related
	Tips	Displays practical advice or shortcuts for installation, operation, or service.
	CE marking	The product complies with applicable EU directives and harmonised standards.
	Read the manual	Please read manual before installation and service.
	Do not dispose of in household waste	The product is covered by the WEEE Directive and must not be disposed of with household waste, it must be recycled and delivered to a recycling centre.
	Recycling	Packaging, products and other materials that do not contain electronics must be recycled in accordance with local environmental regulations.

## INSTALLATION VIDEO



### READ THIS FIRST!

Electronics, regardless of enclosure, are intended for use in a controlled indoor environment. Mains voltage should be disconnected during installation.

It is the installer's responsibility that the system is suitable for its intended use. Only authorized persons should install and maintain the system.

All information subject to change.

<sup>1</sup>Translations in languages other than Swedish are indicative only and not safely reviewed. Translation should always be checked against the Swedish original to ensure accurate information

**ABOUT GLASS TUBE FUSES ON CERTIFIED DEVICES**

There are glass tube fuses on the circuit board's load outputs, these have a tripping time of approx. 150 ms. In the event that a glass tube fuse trips on ONE load output, the voltage on ALL load outputs drops to 0 V for 150 ms.

The installer is responsible for ensuring that there is an energy buffer of at least 150 ms in systems that the battery backup supplies power to or accepts a power failure of 150 ms.

**INSTALLATION — GENERAL INFORMATION**

Installation shall be carried out by a competent electrician in accordance with the applicable national electrical installation rules.

The product is of protection class I and must be connected to a grounded 230 V AC circuit.

- A main switch according to IEC 60947-1 shall be provided in the fixed installation. The switch should be easily accessible and clearly marked with its function.
- The area of the supply cable shall be at least 1,0 mm<sup>2</sup> and fitted with a fuse T 2,5 A (slow-blown) or equivalent.
- AC and low voltage cables must not be pulled together. Keep separate cable chutes or bundles
- Check that protective earth (PE) is properly connected before turning on voltage.
- Ensure free air circulation around the enclosure at least 100 mm, unless otherwise specified. Ventilation openings must not be covered.
- The product is intended for indoor installation in normal environment (pollution number 2 and indoor class 1).

These general requirements apply to all Milleteknik products with 230 V mains connection.

**REQUIREMENTS FOR MAIN SWITCH, FUSE AND CABLE AREA**

In order to comply with applicable electrical safety requirements, the installation shall be equipped with a main switch according to IEC 60947-1.

**Table 3. Main switch and fuse**

Component	Requirements
Main switch	A main switch according to IEC 60947-1 shall be included in the installation and be easily accessible. Separated phase (F) and neutral (N)
Fuse	The supply circuit shall be protected by a fuse or automatic fuse with rated current according to the product specification (normally T 2,5 A slow-blown or equivalent). Refer to the device's nameplate.
Fuses	Approved type according to IEC 60127.
Cross-sectional area (230 V)	At least 1,0 mm <sup>2</sup>
Cable length	In the case of longer wiring, voltage drops should be taken into account so that the operating voltage does not fall below 230 V ± 10% at the unit.
Strain relief	All cables must be properly secured and strain relief checked before energizing the unit.

These requirements apply to all Milleteknik products with 230 V mains connection.

The table below shows recommended cable area for low current installations at different voltages, current strengths and cable lengths. Values are based on copper cable and a maximum voltage drop of approximately 3% to ensure operational reliability.

**Table 4. Cable area weak current**

V	Current strength (A)	Cable length 10 meters	Cable length 30 meters	Cable length 60 meters	Cable length 100 meters
24V	1 A	0,75 mm <sup>2</sup>	0,75 mm <sup>2</sup>	1,5 mm <sup>2</sup>	1,5 mm <sup>2</sup>
24V	3A	0,75 mm <sup>2</sup>	0,75 mm <sup>2</sup>	1,5 mm <sup>2</sup>	2,5 mm <sup>2</sup>
24V	5A	0,75 mm <sup>2</sup>	1,5 mm <sup>2</sup>	2,5 mm <sup>2</sup>	4 mm <sup>2</sup>
24V	10A	1,5 mm <sup>2</sup>	2,5 mm <sup>2</sup>	6 mm <sup>2</sup>	-*
24V	15A	1,5 mm <sup>2</sup>	4 mm <sup>2</sup>	-*	-*
24V	25A	2,5 mm <sup>2</sup>	6 mm <sup>2</sup>	-*	-*
24V	40A	4,0 mm <sup>2</sup>	-*	-*	-*

\* Cable area would exceed connector terminal dimensions therefore it is not possible to use cable larger than 6 mm<sup>12</sup>

YOU CAN FIND MANUALS AT: [WWW.MILLETEKNIK.SE/RCO-DOKUMENT](http://WWW.MILLETEKNIK.SE/RCO-DOKUMENT)

## LINKS TO MANUALS AND PRODUCT SHEETS

You will find manuals and product sheets at: [www.milleteknik.se/rco-dokument](http://www.milleteknik.se/rco-dokument)



## ADDRESS AND CONTACT DETAILS

RCO Security AB  
 Box 3130  
 S-169 03 Solna  
 Sweden  
 +46 8-546 560 00  
[info@rco.se](mailto:info@rco.se)  
[www.rco.se](http://www.rco.se)

## COMPONENT OVERVIEWS

## COMPONENT OVERVIEW BT FLX MEDIUM COM GEN2

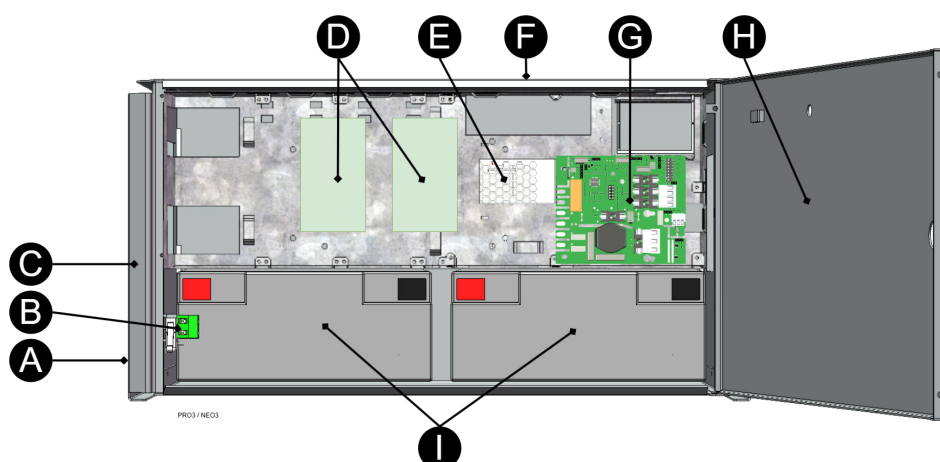

Table 5. Component overview

Letter	Explanation
A	Bracket, reversible for wall mounting or 19" rack.
B	Sabotage contact. If alarm class 3 (SSF) is to be met, the tamper switch must be on the wall.
C	Cabinet in powder-coated sheet metal.
D	Space for distribution cards.
E	Power supply.
F	Cable entries.
G	Motherboard.
H	Lockable door.
I	Space for batteries.

## ENCLOSURES

## CONSOLE

The supplied brackets can be attached in two ways: When mounting on a wall, the brackets must sit backwards, against the wall. When mounting in a 19" rack, the bracket must sit at the front of the unit.

Table 6. Console

Letter	Explanation
A	Console is pushed in from the bottom up.
B	Clip clicks in when bracket is pushed in correctly.

**IMPORTANT**

If alarm class 3 (SSF) is to be met, the cabinet and tamper switch must be mounted on the wall. Optional, Cabinet tamper to put a tamper switch on the wall is available.

## MOUNTING

Use the appropriate screw for mounting on a wall or in a 19" rack. Screws for mounting on a wall or in a rack are not included.

### MOUNTING - WALL MOUNTING

- The products shall be mounted on a stable wall or mounting plate with sufficient bearing capacity for the weight of the enclosure, including batteries.
- The enclosure is mounted vertically.
- Use four screws with a diameter of 4—5 mm, depending on the substrate.
- Recommended distance between screw head and wall should be 1.5-2 mm.
- For mounting on drywall, wall anchors or expanders should be used.
- When mounting on concrete or brick, dowels or equivalent fastening are used.
- For good ventilation, at least 100 mm of free space should be provided above and on the sides of the enclosure.
- The unit should be mounted at a comfortable working height, normally between 1.4 and 1.8 m above the floor.
- Avoid placement in direct sunlight, near heat sources, or in environments with high humidity or dust.
- For outdoor use, only enclosures with the specified IP class for outdoor use shall be used.
- Installation shall be carried out in accordance with the applicable installation rules and by a competent installer.

## OPTIONAL CARDS FOR POWER SUPPLY

**Table 7. Optional cards for power supply**

Power supply	Optional cards fitted on delivery	Additional cards that can be mounted
BT-5 FLX Medium COM Gen2	-	2 pcs. BT-Fuse 5 or 2 pcs. BT-Fuse 10.

## BATTERIES - PLACEMENT AND CONNECTION

### CONNECT BATTERY FUSE / BLADE FUSE

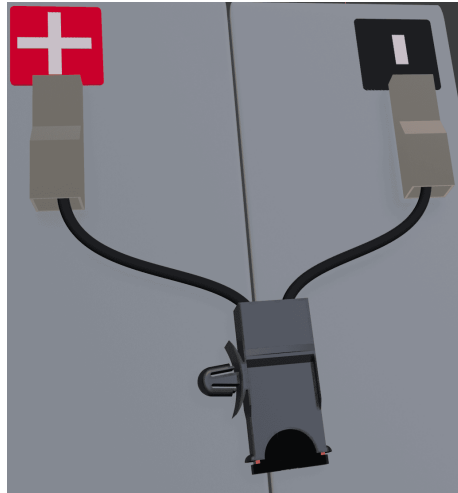
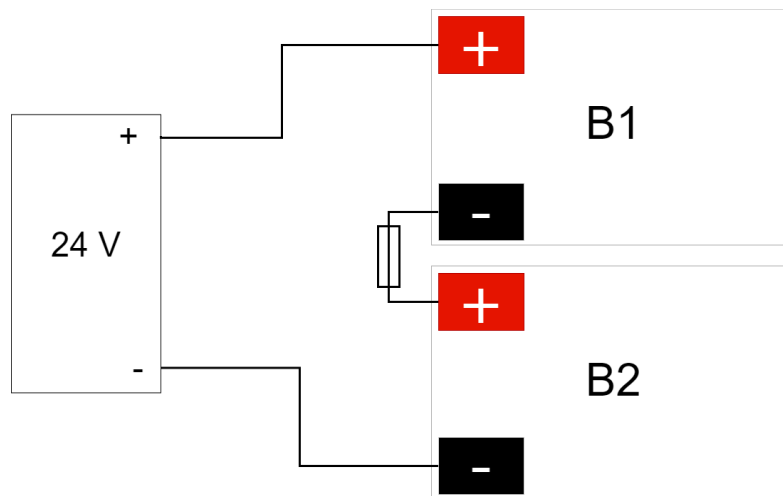

Figure 1. Fuse holders with blade fuses are connected to + and minus on batteries

### CONNECTION OF BATTERIES IN FLX S, FLX M AND FLX L

Battery wiring is mounted on the circuit board upon delivery. Pictures below only show how to connect wiring.

1. Place the batteries in the cabinet with the battery terminals facing outwards.
  2. Connect the battery cable. Red cable on + and black cable on -.
- If possible, disconnect mains voltage when replacing the battery.



Connect the terminals correctly so that you do not damage the equipment.

Figure 2. Wiring diagram for batteries in battery backup

PRO3 MOTHERBOARD

MOTHERBOARD - DESCRIPTION

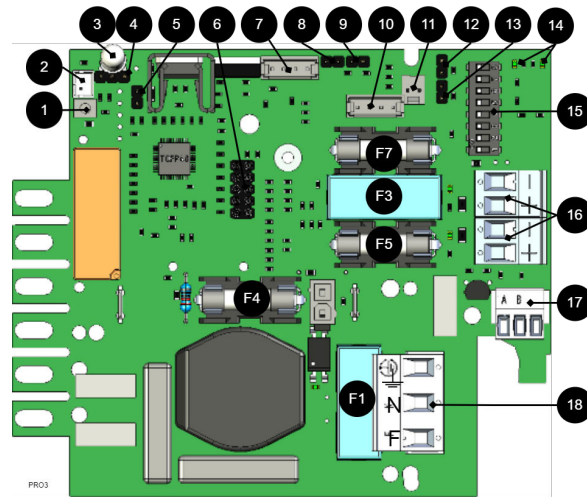

The motherboard controls the device and distributes power. See technical data for more information.

Figure 3. PRO3

Table 8. Circuit Board Overview, Explanation

No .	On circuit board	Explanation
1	J24	Control to power supplies. Internal use.
2	J5	1=Oprio 2=external alarm.
3	D9	LED.
4	JU1	For external LED in door.
5	J11	Reset jumper, used when changing batteries.
6	JU6	Connection for relay cards or communication cards or for updating firmware. Only one card or contact at a time can fit.
7	J29	Connection to fan.
8	J101	Connection to tamper contact.
9	J17	Connection to tamper switch from battery box.
10	J35	Not used.
11	J14	Alarm input from external battery fuse, from battery box.
12 and 13	J10 and J100	Alarm from external option card.
14	D18, D19	LEDs show the status of communication (RS-485).
15	S3	Dip switch
16	P2:1-4	Load outputs
17	P3:1-3	Communication connection, RS-485.
18	P1:1-3	Connection to the mains.

## FUSES

Table 9. Fuses on PRO3 / NEO3

Fuse	Type	Explanation
F1	T2.5A	Mains fuse
F3	T16A	Load fuse 1 - (for P2:2)
F4	T16A	Battery fuse
F5		Load fuse 1+ (for P2: 1)
F7		Load fuse 2 + (for P2:3)



### WARNING FOR REPLACING FUSES (CURRENT STRENGTH, A)

There is a risk of damage if the fuse is changed to a larger one than what the unit is delivered with. The function of the fuse is to protect the connected load and cables against damage and fire. It is not possible to change the fuse to a larger one to increase the power output.

*[sv] Anslut elnät*

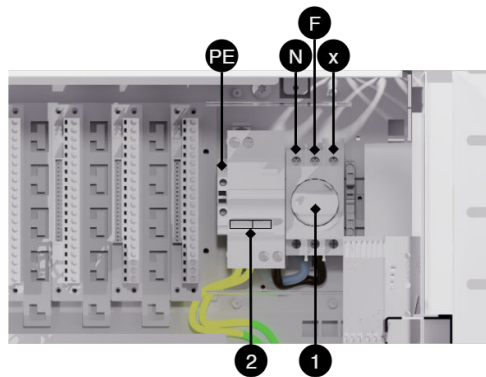

*[sv] För in elnätskablage genom kabelgenomföringar på ovansidan skåpet.*

Table 10. *[sv] Koppla in elnät*

<i>[sv] Beteckning</i>	<i>[sv] Förklaring</i>
1	<i>[sv] Vred för nätspänning.</i>
2	<i>[sv] Personskydd / jordfelsbrytare.</i>
<i>[sv] PE</i>	<i>[sv] Jord.</i>
N	<i>[sv] Nolla.</i>
F	<i>[sv] Fas.</i>
x	<i>[sv] Används ej.</i>

## CONNECT LOAD



### MAX CURRENT

The maximum current must not be exceeded. Max current is indicated on [nameplate](#) on the device.

If there are one or more connection cards (to increase the number of load outputs), load must be connected there and not on the main board.

**Table 11. Load connections**

On circuit boards	Explanation
P2: 1	Connection for load 1 +.
P2: 2	Hookup for load 1 -.
P2: 3	Connection for load 2 +
P2: 4	Connection for load 2 -

## DIP SWITCH 1-8

Dip-Switch has several different modes:

**Table 12. Dip switch 1-8**

Dip switch	In mains operation or in battery operation
1	Address for external communication.
2	Address for external communication
3	Address for external communication
4	Address for external communication
5	Sets alarm for mains failure delay
6	Sets alarm for mains failure delay
7	Sets alarm limit for low battery voltage in battery operation.
8	Turns off or turns on LED indication, for everything except alarm in case of triggered tamper contact which is always indicated regardless of dip-switch position.
8 in sequence	Perform battery tests.

## ADDRESS SETTING FOR EXTERNAL COMMUNICATION (DIP SWITCH 1-4)

Dip-Switch S1: 1-4 sets addressing.

**Table 13. Addressing Dip-Switch 1-4**

	Dip: 1	Dip: 2	Dip: 3	Dip:4
Adress 1	ON	OFF	OFF	OFF
Adress 2	OFF	ON	OFF	OFF
Adress 3	ON	ON	OFF	OFF
Adress 4	OFF	OFF	ON	OFF
Adress 5	ON	OFF	ON	OFF
Adress 6	OFF	ON	ON	OFF

	Dip: 1	Dip: 2	Dip: 3	Dip:4
Adress 7	ON	ON	ON	OFF
Adress 8	OFF	OFF	OFF	ON
Adress 9	ON	OFF	OFF	ON
Adress 10	OFF	ON	OFF	ON
Adress 11	ON	ON	OFF	ON
Adress 12	OFF	OFF	ON	ON
Adress 13	ON	OFF	ON	ON
Adress 14	OFF	ON	ON	ON
Adress 15	ON	ON	ON	ON

## MAINS FAILURE DELAY (DIP 5-6)

It is possible to change the time for when the alarm for a power outage should be given. Use the matrix to set the alarm.

Table 14. Mains failure delay

Alarms for mains failure are given after:	Dip 5	Dip 6
3 seconds	OFF	OFF
30 minutes	ON	OFF
60 minutes	OFF	ON
240 minutes (4 hours)	ON	ON

## LOW BATTERY VOLTAGE (DIP 7)

Dip: 7 has the same function regardless of whether the unit is in mains or battery operation or whether the tamper switch is held down.

Table 15. Low battery voltage

Alarm for low battery voltage is given when	Dip 7
22,8 V*	ON
24 V	OFF
*25% of battery capacity remains.	

## LED (DIP 8)

LED/battery-test always lights up when the door is open.

Dip-switch 8=ON turns off the LED.

Dip-switch 8=OFF turns on the LED.

## BATTERY TEST (DIP 8)

To do a battery test, dip 8 needs to change position and five seconds need to pass before the test is initiated.

- If dip 8 in original position is on OFF then switch dip 8 to: ON (wait 5 seconds) and then switch back to OFF.
- If dip 8 in original position is on ON then switch dip 8 to: OFF (wait 5 seconds) and then switch back to ON.

This activates the battery test after 3-8 seconds. The battery test lasts for about 6 seconds and then the LED flashes yellow quickly. Aged battery alarms may be indicated while the battery test is being performed.

Only reset dip 8 when the test is complete.

### **REBOOT TO CONFIRM CHANGES IN ADDRESS, BATTERY AND ALARM SETTINGS TO PARENT SYSTEM**

After the dip-switch has been set for various parameters, the device's software needs to be restarted. This is for the new settings to be stored and take effect.



#### **IMPORTANT**

Rebooting according to this procedure does not interrupt the output voltage.

Restarting the device software is done by jumpering J11 (PRO3)



#### **IMPORTANT**

Reboot must be done every time a change is made to the device.

NEO cannot be connected to communication/UC.

### **RESET AFTER BATTERY REPLACEMENT -PRO3**

After battery replacement, the device needs to measure the capacity of new batteries and clear previously set battery capacity. All alarms are cleared from the units memory, statistics remains and can not be cleared.

- Insert jumper on J11 and remove jumper on J11

After doing step, the battery capacity is cleared in the units memory and is ready to read the new battery capacity.

This procedure needs to be done each time the batteries are replaced or when connecting a battery box.



#### **NOTE ON TEST OF BATTERIES**

At start-up, it takes 72 hours before the system performs battery tests. This is to ensure fully charged batteries and to collect averages / history for at least 72 hours. Thereafter, every four hours, a qualified cell sample of the batteries is performed.



**NOTE ON START-UP WITH SHORT-CIRCUITED BATTERIES**

Peak current at start-up with short-circuited batteries: Up to 30 A p-p for 200 ms. Always follow the start-up procedure.

**CARD DESCRIPTION - RELAY CARD NOVA SERIES (PRO3)**

Relay card - description, connections and alarm outputs.

The card is connected to the 10-pin header (6) on the PRO3 card.

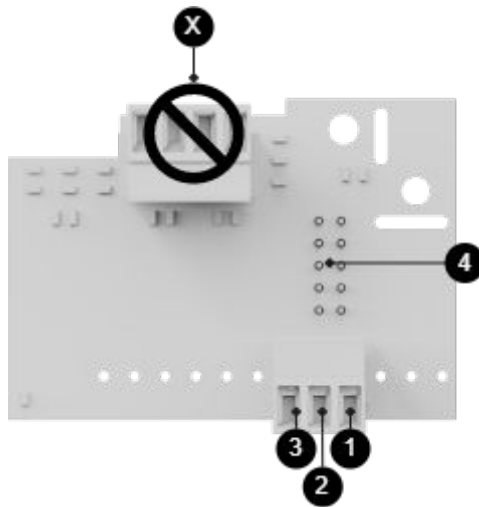

No	On circuit board	Explanation
I <sup>2</sup> C		
1	P5:9	SDA
2	P5:8	SCL
3	P5:7	System minus
4	JU5	Connection to PRO3 card.
X	For internal programming. Do not use.	



**IMPORTANT**

Do you use I<sup>2</sup>C cards, you cannot use relay cards.

**MULTIPLE UNITS INTO ONE PARENT SYSTEM**

To connect several units to a higher system, the load-minus between several battery backups must be connected together.

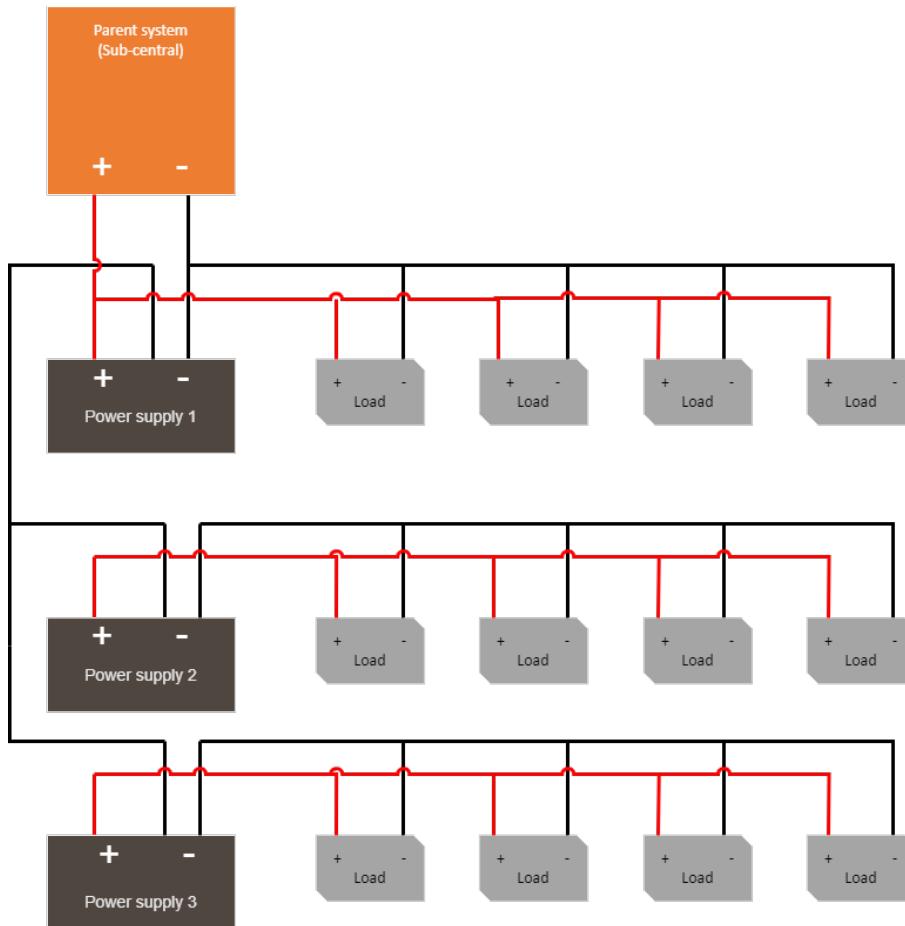

## BRIDGE OF UC-50 GEN2

When installing in environments sensitive to interference, communication interruptions may occur. By bridging to 0 V on the UC-50 Gen2, interference can be avoided.



### IMPORTANT

The bridge must be located: i<sup>2</sup>C, P6 to DC-IN, P6:12.

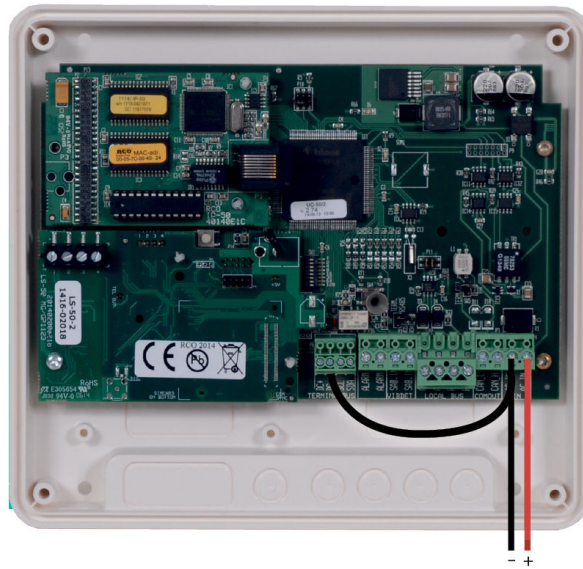

## BUS COMMUNICATION - CONNECTION TO UC-50 GEN2

Connection to UC-50 Gen2 is made according to sketch.

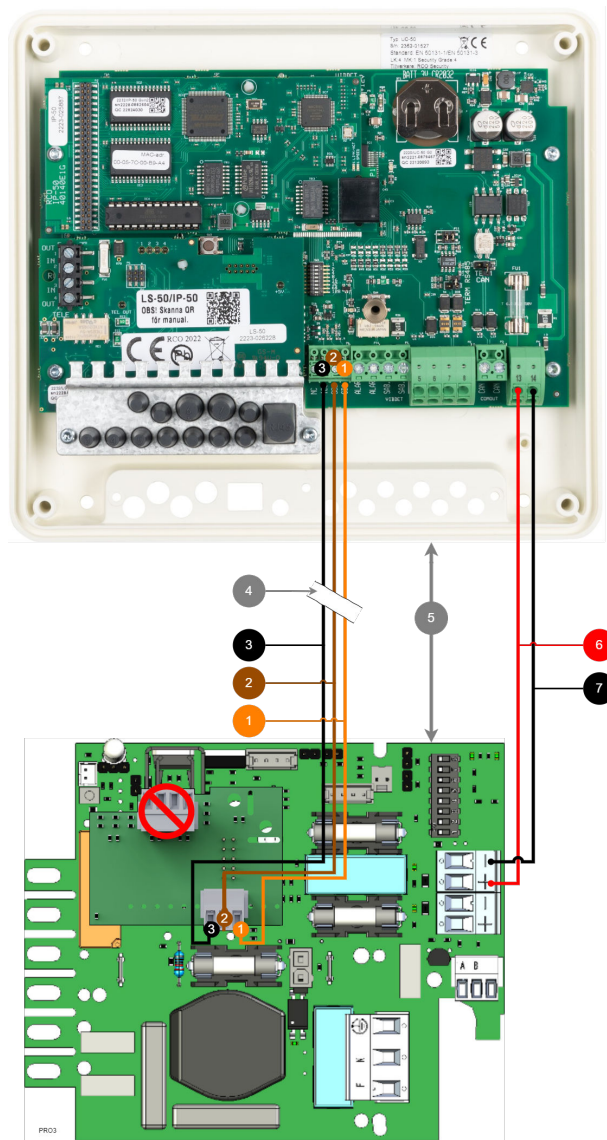

The picture shows the connection from the battery backup to the UC-50 Gen2.

**Figure 4. Connection to UC-50 Gen2**

**Table 16. Bus communication - connection to UC-50 Gen2.**

No	On PCB in UC-50 Gen2	On PCB in power supply	Color of cable	Explanation
1	SDA, P6:42	P5:9	Orange	SDA/DATA.
2	SCL, P6:41	P5:8	Brown	SCL/CLOCK.
3	I <sup>2</sup> C 0V, P6:40	P5:7	Black	V-Ground / minus. Choose any.
4	-	-	-	Untwisted cable. Maximum three meters.
5	-	-	-	Max distance between power supply and UC-50 Gen2: 3 meters.
6	DC+ IN, P4:14	P2:3	RED	24 V.
7	DC- IN, P4:14	P2:4	Black	24 V.



**IMPORTANT**

Cable length max 3 meters. Cable must not be twisted in pairs.

**COMMISSIONING - HOW TO START THE UNIT**

1. connect load, alarm and possibly. other connections.
2. Connect batteries
  - Connect / switch on fuses
3. Screw the mains cable into the terminal block and attach the terminal block to the motherboard.
  - Switch on mains voltage.

**CONNECT IN THIS ORDER**

To minimize the risk of errors that may occur in connection with a short circuit, connections to the motherboard must be made in this order.

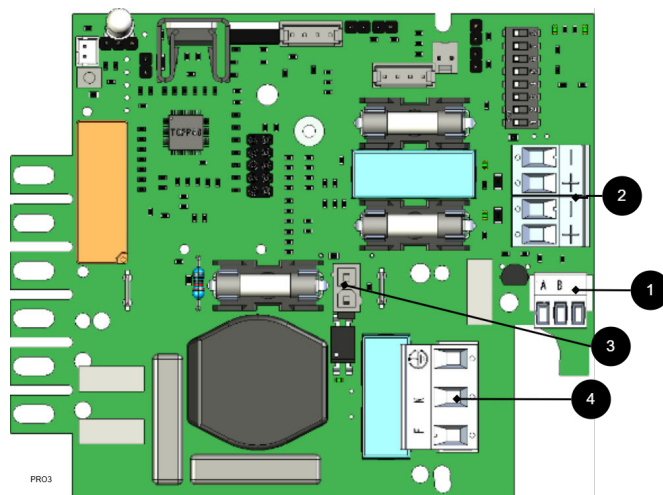

**Table 17. Connect in this order**

Nr	Explanation
1	Connect alarm.
2	Connect load.
3	Connect batteries
4	Connect mains.



**IMPORTANT**

For setting dip switches and addressing — see online manual via QR code.

The unit works normally when the indicator LED on the outside of the cabinet door lights up with a solid green light. See front panel for other status indications.

It may take up to 72 hours before the batteries are fully charged.

## SYSTEM TEST

Test the connected device by performing a system test afterwards [commissioning \[21\]](#).



### IMPORTANT

Let the batteries charge for a couple of hours, use a multimeter to measure the voltage on each battery. The voltage must be at least 12.7 V per battery.

- Switch on incoming mains voltage.
- Indicator LED on the outside of the cabinet door lights up with a solid green light. Disconnect the mains voltage to check that the unit is operating in battery mode and alarms.
- LED on the cabinet door indicates, see panel for alarm type.
- Switch on incoming mains voltage. Indicator LED, on the outside of the cabinet door, lights up with a solid green light. Normal operation.

## RECOVERY

Reset the unit by completely de-energizing the unit.

Disconnect battery wiring and mains voltage and reconnect after 5 seconds.

## ALARM DISPLAYED ON CABINET DOOR

In normal mode, the indicator LED shows a solid green light.

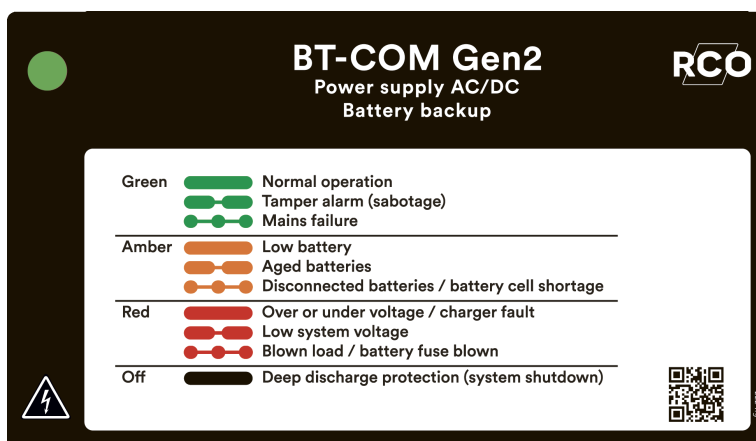

Table 18. The indicator diode shows.

The indicator diode (LED) shows	Explanation
Solid green light	Normal operation.
Slow green flashes	Sabotage alarm.
Fast green flashes	Mains failure.
Solid yellow light	Low battery voltage.
Slow yellow flashes	Aged batteries.
Rapid yellow flashes	Disconnected batteries / battery cell shortage.
Solid red light	Overvoltage or undervoltage or charger fault.
Slow red flashes	Low system voltage.
Rapid red flashes	Blown load / battery fuse has blown.
No light / off	Deep discharge protection is activated. (System shutdown).

When operating system: If the indicator LED is off, deep discharge protection has come into force.



#### NOTICE

If the indicator light flashes every 15 seconds, the battery is fully charged and the charge is in rest phase to extend battery life. In the event of a power failure during the rest phase, the battery backup switches to battery operation as usual

## ADJUSTMENT OF TAMPER SWITCH

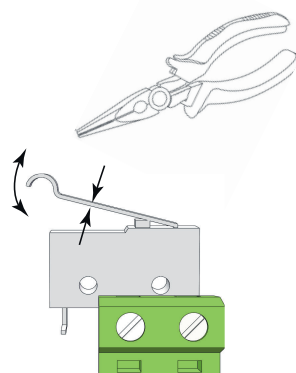

The tamper switch lever must be in the closed position when the cabinet door is closed. If the alarm goes off ("tamper alarm"), the lever may need to be adjusted.

The lever is adjusted by the following steps:

1. Pinch with pliers in the middle of the lever.
2. Carefully adjust the lever in the desired direction (up / down).
3. Check by closing the door. A click is heard when the contact is closed.

**NOTICE**

Tamper switch will not give an alarm when closed and locked the door.

**MAINTENANCE**

The system with the exception of batteries is maintenance-free when installed in an indoor environment.

**ABOUT BATTERIES**

Batteries generate electricity through a chemical process and there is thus a natural degradation of capacity. The biggest factor in battery life is temperature. The higher the temperature, the shorter the battery life. The date of manufacture stamped on the battery and the service life (as stated by the battery manufacturer). An ideal temperature is 20 °C both in operation and in storage. Higher ambient temperature greatly reduces the service life. Thus, actual lifespan varies when used. Batteries should be replaced after half specified (from the battery manufacturer) lifetime for safe operation. Batteries purchased through the manufacturer of the battery backup have a lifespan (from the battery manufacturer) of between 10-12 years with recommended replacement after 5-6 years.

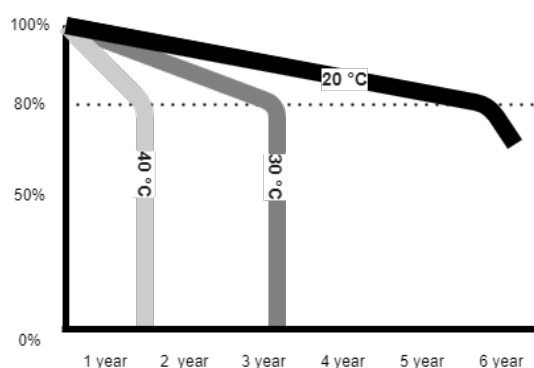

**Table 19.** *[sv] Tillverkarens angivna livslängd och rekommenderat batteribyte*

<i>[sv] Tillverkarens angivna livslängd<sup>a</sup></i>	<i>[sv] Batteri i drift bör bytas efter<sup>b</sup></i>
<i>[sv] 3-5 år</i>	<i>[sv] 2-3 år</i>
<i>[sv] 6-9 år</i>	<i>[sv] 3-5 år</i>
<i>[sv] 10-12 år</i>	<i>[sv] 5-7 år</i>
<i>[sv] 15+ år</i>	<i>[sv] 8-10 år</i>

<sup>a</sup>Gäller vid helt utnyttjat batteri som är lagrat under optimala förhållanden.

<sup>b</sup>Vid drift i idela omgivningstemperatur, 20 °C.

**BATTERY CHANGE**

- If possible, disconnect mains (voltage) when replacing the battery.
- Disconnect battery cables. Note how battery cables are mounted before removing them.
- Remove battery fuse between batteries.
- Insert and fasten the new batteries.

- Connect the battery cables in the same way as before.
- Connect battery fuse between batteries.
- Switch on mains voltage. The indicator LED may not be green (up to 72 hours), until the batteries are charged.
- Test the system by briefly disconnecting the mains voltage, (= the load is driven by the batteries), and then switch on the mains voltage again.

## BATTERY RECYCLING

All batteries must be recycled. Return to manufacturer or return to recycling station.



## APPENDIX: MOUNT I2C BOARD

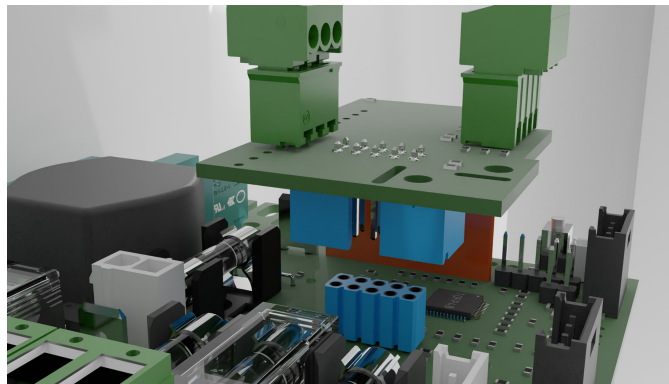

The board is pressed into place on the motherboard in the power supply.

The power supply may be commissioned.

## SAFETY INFORMATION - SERVICE AND TROUBLESHOOTING

- If possible, disconnect the mains supply before starting any work, such as servicing, battery replacement, metering or troubleshooting.
- Remove the battery fuse/plug before working on the DC side.
- Check that all cables are properly connected and grounded before re-energizing the unit.
- The product may contain components that become hot during operation. Avoid touching internal parts immediately after the power has been switched off.
- If fuses disengage repeatedly see [Troubleshooting \[26\]](#) or disconnect the device and contact Milletechnik technical support.
- In case of suspicion of damage, liquid ingress or burnt odour, the product must not be used until it has been checked by competent personnel.
- During operation, the housing should be closed and locked (if the device has a lock).
- Only authorized service personnel may perform repairs on the device.

- Use only original fuses and batteries of the same type and value as specified in the manual/product sheet.

Milletechnik is not responsible for damage caused by improper handling, modification or unapproved components.

## TROUBLESHOOTING

If the device does not work as expected, go through the following checks:

Table 20. Troubleshooting

Problem	Possible cause	Action
No output voltage.	No mains voltage, fuse triggered or battery failure.	Check the supply, fuses and battery connections.
Battery does not charge.	Faulty battery connection or battery fuse has blown.	Check battery cables and replace battery fuse if necessary.
The device starts but alarms.	Batteries not sufficiently charged or faulty load or battery.	Wait 72 hours until the batteries are fully charged. Ensure that the connected load does not exceed the rated current.
LED flashes.	Information, warning or error.	See panel or manual for explanation.
Fuses blow frequently.	Short circuit or overload.	Check connected devices, change the fuse only after the cause is fixed.
The device gets hot	High load or insufficient ventilation	Check that the rated current is not exceeded and that air flow is present around the housing.

If the problem persists after these checks, contact Milletechnik support and provide the product name, serial number and a brief error description.

## POWER SUPPLY - PRODUCT SHEET

### SSF1014 CERTIFIED BATTERY BACKUP WITH COMMUNICATION



### NAME, ARTICLE NUMBER AND E-NUMBER

Table 21. Name, article number and email number.

Name	Article number	E-number
BT-5 FLX Medium COM Gen2	28160143	52 57 699

## ABOUT BT FLX COM GEN2

BT FLX COM Gen2 is mainly used in safety systems where SSF 1014 approved battery backup is required or where the requirements are higher. Requirements such as better flexibility, more alarm functions, longer backup operating times or where the battery backup needs to handle higher loads.

- SSF1014, Alarm class 1-3 approved battery backups / power supply.
- Controlled charging function.
- Qualified battery capacity test
- Can be supplemented with several different optional cards.
- Mounted on a wall or in a 19" rack.
- Flexible battery capacity with battery boxes increases backup operating time.

## FLEXIBILITY

Power supply BT-5 FLX Small COM Gen 2 and BT-10 FLX Small COM Gen 2 can be expanded with an extra battery box: Battery box 24V FLX S with space for four 14 Ah batteries. Power supply BT-5 FLX Medium COM Gen 2, BT-5 FLX Large COM Gen 2, BT-10 FLX Large COM Gen 2, BT-15 FLX Large COM Gen 2 and BT-25 FLX Large COM Gen 2 can be extended by 1- 4 extra battery boxes\*. Power Supply Medium and Power Supply Large can also be expanded with battery shelves in 19" racks\*. Battery box 24V FLX M Has room for two 45 Ah batteries. Battery shelves have room for two 45 Ah batteries (Medium) and two 150 Ah batteries (Large) on each battery shelf\*. \*Adapter required.

## FIXED INSTALLATION

The product is intended for fixed installation. The battery backup must be installed by a qualified installer.

## AREA OF USE

BT FLX COM Gen2 mostly used for: Access control system, burglar alarms, (integrated security systems), in public environments such as schools, offices and commercial properties.



The unit meets the requirements for installation in systems that must be SSF 1014 approved. SSF 1014 certificate is only valid for certification together with a higher-level system.



### IMPORTANT

In order for the SSF 1014 certificate to be valid, only one (1) load output may be used.

## REGULATIONS AND CERTIFICATIONS

### STANDARDS THAT PRODUCT (S) MEET AND ARE APPROVED FOR

Table 22. SBF

SBF 110:8

Table 23. SSF

SSF1014 Alarm class 1-4 (burglar alarm).

Table 24. Certificate and certificate number

Certificate number, SBSC	Designation SBSC
No. 20-117	NOVA 27 50-FLX S • NOVA 27 100-FLX S • NOVA 27 50-FLX M • NOVA 27 100-FLX M • NOVA 27 150-FLX M • NOVA 27 250-FLX M • NOVA 27 50-FLX L • NOVA 27 100-FLX L • NOVA 27 150-FLX L • NOVA 27 250-FLX L Unison Facility Cabinet

## REQUIREMENTS THAT THE PRODUCT MEETS

Table 25. The product meets the following requirements.

EMC:	EMC Directive 2014 / 30EU
Electricity:	Low voltage directive: 2014/35 / EU
CE:	EC Directive in force: 765/2008
Emission	EN55032 (CISPR32) Class B
Machinery Directive	The product is part of electrical systems, is subject to the relevant electrical and safety directives and is not a machine according to the Machinery Directive (2006/42/EC).
Ecodesign	Milletechnik's products are intended for professional use and are therefore not directly covered by the Ecodesign Regulation (EU 2019/1782). As some components may be covered, we nevertheless disclose relevant information to give our customers confidence in their choice

Efficiency (%)<sup>a</sup>.

Standby consumption, typical (W):

<sup>a</sup>.At rated load.



## POWER OUTLET PER PRODUCT

Article name:	Battery capacity:	Possible average load according to LK1 / LK2:	Possible average load according to LK3 / LK4:
BT-5 FLX Small COM Gen2 + Batteribox 24V FLX S	6 pcs 14 Ah (42 Ah)	3.4 A	1.4 A
BT-5 FLX Medium COM Gen2	2 pcs. 20 Ah	1.6 A	0.65 A
BT-5 FLX Medium COM Gen2 + Battery box 24V FLX M	2 pcs. 45 Ah	3.7 A	1.5 A

## CIRCUIT BOARDS - TECHNICAL DATA

### TECHNICAL DATA, MOTHERBOARD: PRO 3

Info	Explanation
Short name:	PRO 3
Product description	Motherboard in battery backup with advanced functions and communication to parent system.
Own consumption, with relay card	Less than 100 mA. All relays retracted on external alarm card in normal mode.
Switching time from mains voltage to battery operation	When batteries are idle: <5 microseconds. When batteries are in charge cycle: 0 (none). Batteries rest for 20-day cycles, after which a charging cycle picks up and charges the batteries for 72 hours. If there is a power failure when batteries are in the charge cycle, there is no switching time.
Incoming electricity network	230 V AC -240 V AC, 47-63 Hz.
Fuse on mains	See table: Fuses.
Indication	Indicator diode on circuit board / cabinet door

## ALARM

Alarm displayed on indicator LED on the front of the cabinet.

- Cell fault in battery or unconnected battery.
- Charger fault, undervoltage.
- Charger fault, overvoltage.
- Low system voltage, system voltage below 24.0 V in mains operation.
- Low battery voltage, below 24.0 V DC in case of mains failure.
- Power failure alarm.
- Sabotage switch.
- Fuse fault.
- Aged battery

Expanding alarm functions are available via communication or with alarm cards.

**Table 26. Fuses**

Fuses	Type
5 A	T5A
Mains fuse for 24 V units up to 15 A	T2.5AH250V. Ceramic.

**Table 27. Protection**

Info	Explanation
Deep discharge protection (Yes / No)	Yes. 12 V units protection at 10V, +/- 0.5 V. 24 V units protection at 20, +/- 0.5 V.
Surge protection (Yes / No)	Yes
Overtemperature protection (Yes / No)	Yes
Short circuit protected = (Yes / No)	Yes

## TECHNICAL DATA, PRO3 I2C BOARD

Info	Explanation
Card name:	PRO3 I2C board
Version:	1.6

## Power Supply

Info	Explanation
Product description	Card that makes it possible to communicate with UC via i2C.
Recommended environment	Indoors, class 1. Ambient temperature: + 5 ° C - 40 ° C.
Protection class	IPX0
Recommended installation	Battery backup with PRO3 motherboard.
Input voltage	27,3 VDC
Self-consumption	10 mA
Alarm via	I <sup>2</sup> C
Number of alarm outputs	4 pcs
The product meets the requirements according to	CE directive according to: 765/2008, EMC Directive 2014 / 30EU, Emission: EN61000-6-: 2001, EN55022: 1998: -A1: 2000, A2: 2003 Class B, EN61000-3-2: 2001, Immunity: EN61000- 6-2: 2005, EN61000-4-2, -3, 4, -5, -6, -11. SS-EN 50 130-4: 2011 Edition 2 & SSF1014 Alarm class 1-4 (Burglar alarm).

Manufactured in Milleteknik's factory in Partille, Sweden.

This translation is not verified and should be cross referenced with the swedish original before use.

**Table 28. Alarm overview**

Alarm overview in alphabetical order	Communication (P5: 1-9)	Indicator LED on main card and LED on door.
Network outages	X	X
Fuse fault	X	X
Sabotage switch	X	X
Fan fault	X	-
Charger fault, overvoltage	X	X
Charger fault, undervoltage	X	X
Cell fault or unconnected battery	X	X
Low system voltage. **	X	X
Low battery voltage (<24.0 V DC) or power failure	X	X
Overtemperature	X	-
Undertemperature	X	-
Undertemperature	X	-
Short battery life left	X	-
Aged battery	X **	X **
Overcurrent 80%, daily average	X	-
Overcurrent 100%, minute average	X	-
Overcurrent 175%, second average	X	-

## POWER SUPPLY

### POWER SUPPLY - TECHNICAL DATA LRS-150-24

In:
BT-5 FLX MEDIUM COM Gen 2

Info	Explanation
Output voltage	27.3 V
Output current:	0 A - 6.5 A
Output voltage, ripple	200 mVp-p
Overvoltage	28.8 V - 33.6 V

Info	Explanation
Voltage recharge, ripple / current limitation	Less than 0.6 V <sub>p-p</sub>
Efficiency	89%
Current limitation	110% - 140%
Constant voltage	+/- 0.5%
Regulatory accuracy	+ / - 1.0%
Input current (230 V)	1,7 A
Mains voltage frequency	47 Hz- 63 Hz
Mains voltage	230 V AC - 240 V AC
Brand effect	156 W
Temperature range	-30°C - +70°C
Humidity range	20% - 90% RH non-condensed
<p>The power supply is adapted and calibrated with the battery / hardware of the battery backup. Only power and calibrated power supplies may be used. Contact support when changing power supplies. Use of power supplies coming from another source may cause damage not covered by the warranty. Warranty is canceled if power supplies (from a source other than support / designated by support) that are not correctly calibrated are used.</p>	

## TECHNICAL DATA ENCLOSURES

### ENCLOSURES - TECHNICAL DATA FLX M

Info	Explanation
Name	FLX M
Enclosure class	IP 32
Measure	Height: 224 mm, width 438 mm, depth 212 mm
Height units	5 HE
Mounting	Wall or 19 "rack
Ambient temperature	+ 5 ° C - + 40 ° C. For best battery life: + 15 ° C to + 25 ° C.
Environment	Environmental class 1, indoors. 20% ~ 90% relative humidity
Material	Powder coated sheet
Color	Black
Cable entries, number	4
Batteries that fit	2 pieces 12 V, 20 Ah. 2 pcs 12 V, 45 Ah.

## WARRANTY, SUPPORT, COUNTRY OF MANUFACTURE AND COUNTRY OF ORIGIN

### WARRANTY 5 YEARS

The product has a five-year warranty, from the date of purchase (unless otherwise agreed). Free support during the warranty period is reached at [support@milleteknik.se](mailto:support@milleteknik.se) or telephone, +46 31-34 00 230. Compensation for travel and or working hours in connection with the location of faults, installation of repaired or replaced goods is not included in the warranty. Contact Milleteknik for more information. Milleteknik provides support during the product's lifetime, however, no later than 10 years after the date of purchase. Switching to an equivalent product may occur if Milleteknik deems that repair is not possible. Support may be added (at Milleteknik's descretion) after the warranty period has expired.

## SUPPORT

Do you need help with installation or connection?

You will find answers to many questions at: [www.milleteknik.se/support](http://www.milleteknik.se/support)

Phone: +46 31-340 02 30

Support is open: Monday-Thursday 08:00-16:00, Fridays 08:00-15:00. Closed 11:30-13:15.

## SPARE PARTS

Contacted support for questions about spare parts.

## SUPPORT AFTER THE WARRANTY PERIOD

Milleteknik provides support during the life of the product, but no longer than 10 years after the date of purchase. Replacement for an equivalent product may occur if the manufacturer deems that repair is not possible. Costs for support and replacement are added after the warranty period has expired.

## COUNTRY OF MANUFACTURE

Country of manufacture / country of origin is Sweden. For more information, contact your seller.

## DESIGNED AND PRODUCED BY: MILLETEKNIK AB

Designed and produced by Milleteknik AB

## BATTERIES - RECOMMENDED, NOT INCLUDED

### BATTERIES ARE NOT INCLUDED THEY ARE SOLD SEPARATELY

Batteries are sold separately.

## 20 AH, 12 V AGM BATTERY

Fits in	Number of batteries
BT-5 FLX Medium COM Gen 2	2

Battery type	V	Ah
Maintenance-free AGM, lead-acid battery.	12 V	20 Ah

Table 29. 10+ Design life \* battery

Article number	E-number	Article name	Terminal	Measure. Height width depth	Weight per piece	Make
MT113-12V20-01	5230538	UPLUS 12V 20Ah 10+ Design Life battery	M5 Bult	182x77x168 mm	6.0 kg	UPLUS

\*Design life is the shelf life in years for an unused battery. Environmental factors such as heat and load affect the service life. Batteries that have a durability (+10 Design Life) of 10+ years usually need to be replaced after 5-6 years.

## CONNECTION OF BATTERY BOX

### MOUNTING BATTERY BOX WITH BATTERY BACKUP

The battery box is pushed in during the battery backup, (or previous battery box). The battery box is then screwed to a rack or wall. The two enclosures must meet each other without gap.

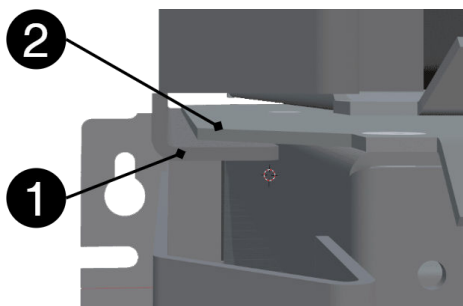

Table 30. Mounting FLX on FLX.

Nr	Explanation
1	Track in battery backup.
2	Protruding part on the roof of the battery box.

### INSTALLATION OF BATTERY BOX, WHAT TO DO IN BATTERY BACKUP

Cable gland / knock-out is located on the underside of the battery backup and must be disconnected before mounting.

The unit must be de-energized during installation and connection.

- Use the wiring that comes with the battery box to meet the wiring from the battery backup. See picture.

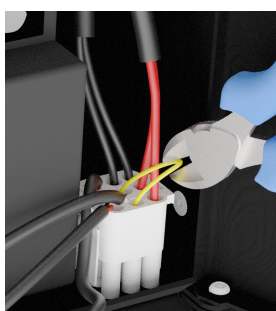

The picture shows cable wiring from the battery backup that meets cables from the battery box

## CONNECTION TO BATTERYBOX

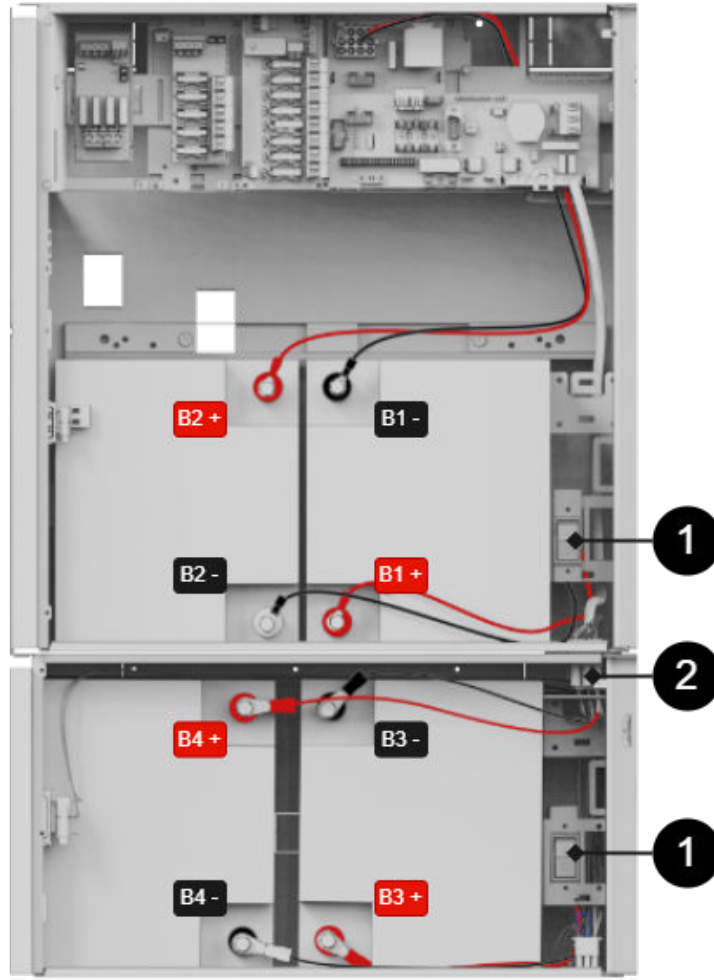

The picture also gives an overview of connection points for battery cables and battery fuses.

**Table 31. Connecting battery box with battery backup.**

Battery cables	Explanation
B1+	Connects to fuse .
B1-	Cable from motherboard is connected to battery .
B2+	Cable from motherboard is connected to battery .
B2-	Connects to fuse .
B3+	Connects to fuse .
B3-	Connected via connector to battery in battery backup .
B4+	Connected via connector to battery in battery backup .
B4-	Connects to fuse .

**Table 32. Connection**

Number	Explanation
1	Battery fuse.
2	Connect battery backup and battery box with white square connector.

## ADDRESS AND CONTACT DETAILS

RCO Security AB

Box 3130

S-169 03 Solna

Sweden

+46 8-546 560 00

[info@rco.se](mailto:info@rco.se)

[www.rco.se](http://www.rco.se)

---

This page is intentionally left blank.

---